

**Immersion / screw-in / duct temperature sensor,  
with passive output**

**TF 54**  
Basic unit

Resistance thermometer / temperature sensor **THERMASGARD® TF 54** with passive output, with connecting head made from aluminium (optionally with **cable gland** or **M12 connector** according to DIN EN 61076-2-101) and straight protective tube.

A basic unit in four variants through combination with accessories, eg, for robust applications with a separate immersion sleeve made from stainless steel.

The duct sensor is used to detect temperatures in liquid or gaseous media. It is used in pipes, heating engineering, storage systems, compact district heating stations, warm and cold water systems, oil and lubrication cycle systems, mechanical, apparatus and plant engineering and throughout the industrial sector.



**TECHNICAL DATA**

Measuring range:	-35...+180 °C ( $T_{max}$ NTC = +150 °C, $T_{max}$ LM235Z = +125 °C)
Sensors / output:	see table, passive <b>(Perfect Sensor Protection)</b> (optionally also with two or other sensors)
Connection type:	2-wire connection (4-wire connection on PT100, optional on other sensors)
Testing current:	< 0.6 mA (Pt1000) < 1.0 mA (Pt100) < 0.3 mA (Ni1000, Ni1000 TK5000) < 2.0 mW (NTC xx) 400 µA...5 mA (LM235Z)
Insulating resistance:	≥ 100 MΩ, at +20 °C (500 V DC)
Electrical connection:	0.14 - 2.5 mm <sup>2</sup> , via terminal screws on ceramic bas
Cable connection:	<b>TF 54</b> (standard) adjusting screw made of metal (M20 x 1,5) <b>TF 54-KV</b> (optional) cable gland, brass, nickel-plated (M20 x 1.5; with strain relief, exchangeable, inner diameter 6 - 12 mm) <b>TF 54-Q</b> (optional) M12 connector according to DIN EN 61076-2-101 (male, 5-pin, A-code)
Dimensions:	see dimensional drawing
Connecting head:	form B, material aluminium, colour white aluminium (similar RAL 9006), ambient temperature -20...+100 °C
Protective tube:	stainless steel, V4A (1.4571), Ø = 6 mm, inserted length (EL) = 50 - 400 mm (see table)
Process connection:	by means of immersion sleeve or mounting flange (Accessories)
Humidity:	< 95 % RH, non-precipitating air
Protection class:	III (according to EN 60 730)
Protection type:	<b>IP 54</b> (according to EN 60 529) <b>TF 54</b> <b>IP 65</b> (according to EN 60 529) <b>TF 54-KV / TF 54-Q</b>
<b>ACCESSORIES</b>	(see table)
<b>TH-MS / xx</b>	<b>Immersion sleeve, brass, nickel-plated / galvanised</b> Ø = 8 mm, $T_{max}$ = +150 °C, $p_{max}$ = 10 bar
<b>TH-VA / xx</b>	<b>Immersion sleeve, stainless steel, V4A (1.4571),</b> Ø = 8 mm, $T_{max}$ = +600 °C, $p_{max}$ = 40 bar
<b>TH-VA / xx / 90</b>	<b>Immersion sleeve, stainless steel, V4A (1.4571),</b> with neck tube (90 mm), Ø = 8 mm, $T_{max}$ = +600 °C, $p_{max}$ = 40 bar
<b>MF-06-M</b>	<b>Mounting flange, metal, galvanised steel, Ø = 32 mm,</b> Ø = 6.3 mm tube gland, $T_{max}$ = +700 °C



2-wire connection

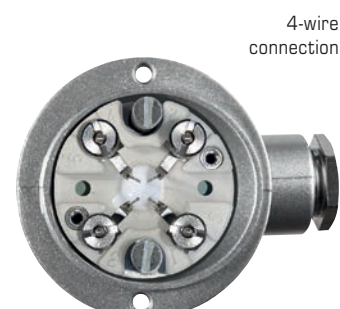

4-wire connection

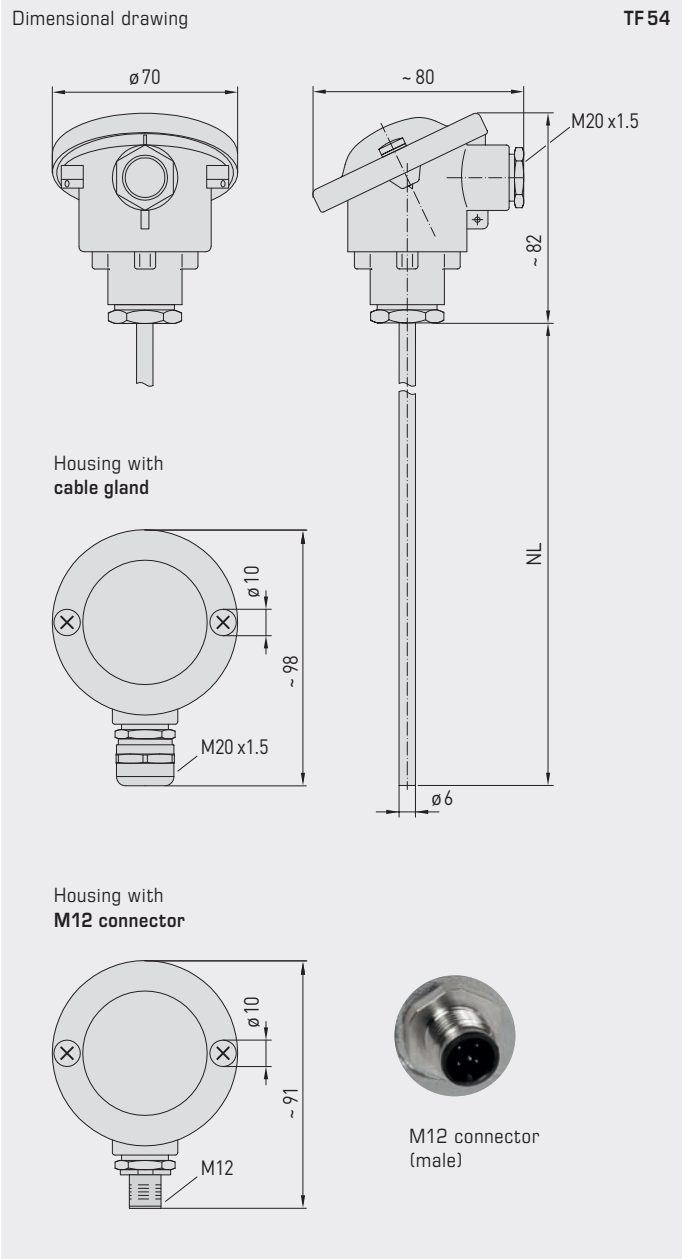

TF 54  
Standard  
(IP 54)



TF 54-KV  
with cable gland  
(IP 65)



TF 54-Q  
with M12 connector  
(IP 65)



High-performance encapsulation against vibration, mechanical stress and humidity

**S+ PS-PROTECTION**  
PERFECT SENSOR PROTECTION

Immersion / screw-in / duct temperature sensor,  
with passive output

TF54  
standard  
(IP 54)

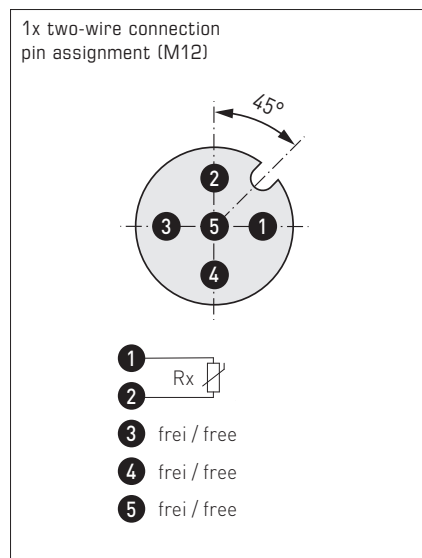
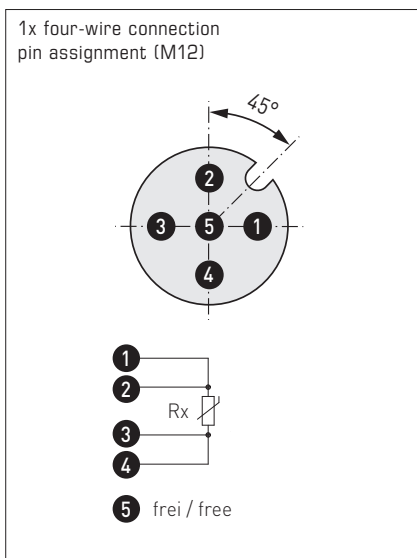
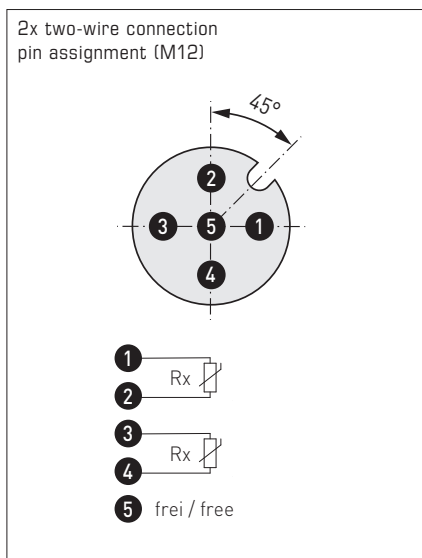
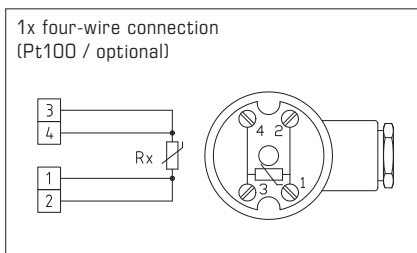
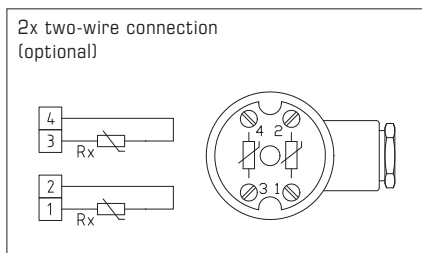
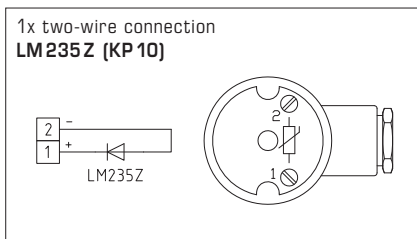
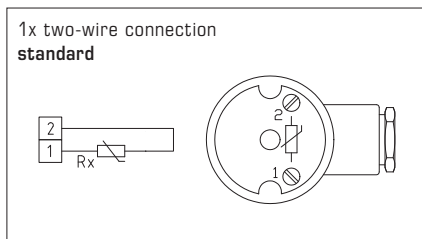

THERMASGARD® Temperature sensor (Basic unit)  
TF 54

Type / WG03	Sensor / Output	Installation length (EL)	Item No.	Price
<b>TF 54 Pt100 xx</b>	<b>Pt100</b> (according to DIN EN 60751, class B)		<b>IP 54, 4-wire</b>	
TF54 Pt100 50mm	Pt100	50 mm	1101-7050-1013-000	73,23 €
TF54 Pt100 100mm	Pt100	100 mm	1101-7050-1023-000	75,01 €
TF54 Pt100 150mm	Pt100	150 mm	1101-7050-1033-000	76,62 €
TF54 Pt100 200mm	Pt100	200 mm	1101-7050-1043-000	79,57 €
TF54 Pt100 250mm	Pt100	250 mm	1101-7050-1053-000	79,91 €
TF54 Pt100 300mm	Pt100	300 mm	1101-7050-1063-000	80,20 €
TF54 Pt100 400mm	Pt100	400 mm	1101-7050-1083-000	81,32 €
<b>TF 54 Pt1000 xx</b>	<b>Pt1000</b> (according to DIN EN 60751, class B)		<b>IP 54, 2-wire</b>	
TF54 Pt1000 50mm	Pt1000	50 mm	1101-7050-5011-000	73,23 €
TF54 Pt1000 100mm	Pt1000	100 mm	1101-7050-5021-000	75,01 €
TF54 Pt1000 150mm	Pt1000	150 mm	1101-7050-5031-000	76,62 €
TF54 Pt1000 200mm	Pt1000	200 mm	1101-7050-5041-000	79,57 €
TF54 Pt1000 250mm	Pt1000	250 mm	1101-7050-5051-000	79,98 €
TF54 Pt1000 300mm	Pt1000	300 mm	1101-7050-5061-000	80,20 €
TF54 Pt1000 400mm	Pt1000	400 mm	1101-7050-5081-000	81,32 €

Continued on next page...



THERMASGARD® TF 54		Temperature sensor (Basic unit)		
Type/WG03	Sensor/Output	Installation length (EL)	Item No.	Price
<b>TF 54 Ni1000 xx</b>	<b>Ni 1000</b> (according to DIN EN 43760, class B, TCR = 6180 ppm/K)		<b>IP 54, 2-wire</b>	
TF54 Ni1000 50mm	Ni1000	50 mm	1101-7050-9011-000	74,51 €
TF54 Ni1000 100mm	Ni1000	100 mm	1101-7050-9021-000	76,63 €
TF54 Ni1000 150mm	Ni1000	150 mm	1101-7050-9031-000	77,88 €
TF54 Ni1000 200mm	Ni1000	200 mm	1101-7050-9041-000	79,64 €
TF54 Ni1000 250mm	Ni1000	250 mm	1101-7050-9051-000	80,13 €
TF54 Ni1000 300mm	Ni1000	300 mm	1101-7050-9061-000	80,42 €
TF54 Ni1000 400mm	Ni1000	400 mm	1101-7050-9081-000	81,62 €
<b>TF 54 Ni1000TK xx</b>	<b>Ni1000 TK5000</b> (TCR = 5000 ppm/K), LG-Ni1000		<b>IP 54, 2-wire</b>	
TF54 NiTK 50mm	Ni1000 TK5000	50 mm	1101-7051-0011-000	74,80 €
TF54 NiTK 100mm	Ni1000 TK5000	100 mm	1101-7051-0021-000	77,55 €
TF54 NiTK 150mm	Ni1000 TK5000	150 mm	1101-7051-0031-000	78,83 €
TF54 NiTK 200mm	Ni1000 TK5000	200 mm	1101-7051-0041-000	79,92 €
TF54 NiTK 250mm	Ni1000 TK5000	250 mm	1101-7051-0051-000	80,42 €
TF54 NiTK 300mm	Ni1000 TK5000	300 mm	1101-7051-0061-000	80,67 €
TF54 NiTK 400mm	Ni1000 TK5000	400 mm	1101-7051-0081-000	81,90 €
<b>TF 54 LM235Z xx</b>	<b>LM235Z</b> (TCR = 10 mV/K; 2.73 V at 0°C), KP10		<b>IP 54, 2-wire</b>	
TF54 LM235Z 50mm	LM235Z	50 mm	1101-7052-1011-000	74,75 €
TF54 LM235Z 100mm	LM235Z	100 mm	1101-7052-1021-000	75,23 €
TF54 LM235Z 150mm	LM235Z	150 mm	1101-7052-1031-000	75,35 €
TF54 LM235Z 200mm	LM235Z	200 mm	1101-7052-1041-000	76,21 €
TF54 LM235Z 250mm	LM235Z	250 mm	1101-7052-1051-000	78,18 €
TF54 LM235Z 300mm	LM235Z	300 mm	1101-7052-1061-000	78,81 €
TF54 LM235Z 400mm	LM235Z	400 mm	1101-7052-1081-000	80,13 €
<b>TF 54 NTC 1,8K xx</b>	<b>NTC 1,8K</b>		<b>IP 54, 2-wire</b>	
TF54 NTC1,8K 50mm	NTC 1,8K	50 mm	1101-7051-2011-000	74,39 €
TF54 NTC1,8K 100mm	NTC 1,8K	100 mm	1101-7051-2021-000	78,81 €
TF54 NTC1,8K 150mm	NTC 1,8K	150 mm	1101-7051-2031-000	79,21 €
TF54 NTC1,8K 200mm	NTC 1,8K	200 mm	1101-7051-2041-000	79,77 €
TF54 NTC1,8K 250mm	NTC 1,8K	250 mm	1101-7051-2051-000	81,12 €
TF54 NTC1,8K 300mm	NTC 1,8K	300 mm	1101-7051-2061-000	81,90 €
TF54 NTC1,8K 400mm	NTC 1,8K	400 mm	1101-7051-2081-000	82,20 €
<b>TF 54 NTC10K xx</b>	<b>NTC 10K</b>		<b>IP 54, 2-wire</b>	
TF54 NTC10K 50mm	NTC 10K	50 mm	1101-7051-5011-000	74,39 €
TF54 NTC10K 100mm	NTC 10K	100 mm	1101-7051-5021-000	78,81 €
TF54 NTC10K 150mm	NTC 10K	150 mm	1101-7051-5031-000	79,21 €
TF54 NTC10K 200mm	NTC 10K	200 mm	1101-7051-5041-000	79,77 €
TF54 NTC10K 250mm	NTC 10K	250 mm	1101-7051-5051-000	81,12 €
TF54 NTC10K 300mm	NTC 10K	300 mm	1101-7051-5061-000	81,90 €
TF54 NTC10K 400mm	NTC 10K	400 mm	1101-7051-5081-000	82,20 €
<b>TF 54 NTC20K xx</b>	<b>NTC 20K</b>		<b>IP 54, 2-wire</b>	
TF54 NTC20K 50mm	NTC 20K	50 mm	1101-7051-6011-000	74,39 €
TF54 NTC20K 100mm	NTC 20K	100 mm	1101-7051-6021-000	78,81 €
TF54 NTC20K 150mm	NTC 20K	150 mm	1101-7051-6031-000	79,21 €
TF54 NTC20K 200mm	NTC 20K	200 mm	1101-7051-6041-000	79,77 €
TF54 NTC20K 250mm	NTC 20K	250 mm	1101-7051-6051-000	81,12 €
TF54 NTC20K 300mm	NTC 20K	300 mm	1101-7051-6061-000	81,90 €
TF54 NTC20K 400mm	NTC 20K	400 mm	1101-7051-6081-000	82,20 €
<b>Housing variant:</b>	equipped as standard with pressure screw (IP 54), optional housing variants with cable gland (IP 65) or M12 connector (IP 65) see the next page!			
Extra charge:	optionally also with two or other sensors			on request

Immersion/screw-in/duct temperature sensor,  
with passive output

**TF 54 - Q**  
with M12 connector  
(IP 65)



THERMASGARD®		Temperature sensor (Basic unit with M12 connector)			
Type/WG03	Sensor/Output	Installation length (EL)	Q	Item No.	Price
<b>TF 54 Pt100 xx Q</b>	<b>Pt100</b> (according to DIN EN 60751, class B)		●	<b>IP 65, 4-wire</b>	
TF54 Pt100 50mm Q	Pt100	50 mm	●	2Z01-4111-0100-011	119,49 €
TF54 Pt100 100mm Q	Pt100	100 mm	●	2Z01-4111-0100-021	121,26 €
TF54 Pt100 150mm Q	Pt100	150 mm	●	2Z01-4111-0100-031	122,89 €
TF54 Pt100 200mm Q	Pt100	200 mm	●	2Z01-4111-0100-041	125,81 €
TF54 Pt100 250mm Q	Pt100	250 mm	●	2Z01-4111-0100-051	126,18 €
TF54 Pt100 300mm Q	Pt100	300 mm	●	2Z01-4111-0100-061	126,46 €
TF54 Pt100 400mm Q	Pt100	400 mm	●	2Z01-4111-0100-081	127,59 €
<b>TF 54 Pt1000 xx Q</b>	<b>Pt1000</b> (according to DIN EN 60751, class B)		●	<b>IP 65, 2-wire</b>	
TF54 Pt1000 50mm Q	Pt1000	50 mm	●	2Z05-4111-0100-011	119,49 €
TF54 Pt1000 100mm Q	Pt1000	100 mm	●	2Z05-4111-0100-021	121,26 €
TF54 Pt1000 150mm Q	Pt1000	150 mm	●	2Z05-4111-0100-031	122,89 €
TF54 Pt1000 200mm Q	Pt1000	200 mm	●	2Z05-4111-0100-041	125,81 €
TF54 Pt1000 250mm Q	Pt1000	250 mm	●	2Z05-4111-0100-051	126,18 €
TF54 Pt1000 300mm Q	Pt1000	300 mm	●	2Z05-4111-0100-061	126,46 €
TF54 Pt1000 400mm Q	Pt1000	400 mm	●	2Z05-4111-0100-081	127,59 €
<b>Housing variant "Q":</b>	Cable connection with M12 connector (male, 5-pin, A-code)				
Extra charge:	optionally also with two or other sensors			on request	

**ACCESSORIES**

Special accessories for M12 connector  
see chapter Accessories!



TF54 - KV  
with cable gland  
(IP 65)



THERMASGARD®		Temperature sensor (Basic unit with cable gland)		
Type / WG03	Sensor / Output	Installation length (EL)	Item No.	Price
<b>TF54 Pt100 xx KV</b>	<b>Pt100</b> (according to DIN EN 60751, class B)		<b>IP65, 4-wire</b>	
TF54 Pt100 50mm KV	Pt100	50 mm	1101-7070-1013-000	83,64 €
TF54 Pt100 100mm KV	Pt100	100 mm	1101-7070-1023-000	85,41 €
TF54 Pt100 150mm KV	Pt100	150 mm	1101-7070-1033-000	87,02 €
TF54 Pt100 200mm KV	Pt100	200 mm	1101-7070-1043-000	86,38 €
TF54 Pt100 250mm KV	Pt100	250 mm	1101-7070-1053-000	90,33 €
TF54 Pt100 300mm KV	Pt100	300 mm	1101-7070-1063-000	90,59 €
TF54 Pt100 400mm KV	Pt100	400 mm	1101-7070-1083-000	91,74 €
<b>TF54 Pt1000 xx KV</b>	<b>Pt1000</b> (according to DIN EN 60751, class B)		<b>IP65, 2-wire</b>	
TF54 Pt1000 50mm KV	Pt1000	50 mm	1101-7070-5011-000	83,65 €
TF54 Pt1000 100mm KV	Pt1000	100 mm	1101-7070-5021-000	85,41 €
TF54 Pt1000 150mm KV	Pt1000	150 mm	1101-7070-5031-000	83,45 €
TF54 Pt1000 200mm KV	Pt1000	200 mm	1101-7070-5041-000	89,98 €
TF54 Pt1000 250mm KV	Pt1000	250 mm	1101-7070-5051-000	90,34 €
TF54 Pt1000 300mm KV	Pt1000	300 mm	1101-7070-5061-000	87,24 €
TF54 Pt1000 400mm KV	Pt1000	400 mm	1101-7070-5081-000	91,74 €
<b>Housing variant "KV":</b>	<b>Cable connection with cable gland</b>			
Extra charge:	optionally also with two or other sensors			on request

Immersion / screw-in / duct temperature sensor,  
with passive output

One basic device in four variants ...



**TF 54 +  
TH -MS/xx**

Immersion / screw-in  
temperature sensor  
with immersion sleeve, brass,  
nickel-plated / galvanised

**TF 54 +  
TH -VA/xx**

Immersion / screw-in  
temperature sensor  
with immersion sleeve,  
stainless steel, V4A

**TF 54 +  
TH -VA/xx/90**

Immersion / screw-in  
temperature sensor with  
immersion sleeve with neck  
tube, stainless steel, V4A

**TF 54 +  
MF-06-M**

Duct temperature sensor  
with mounting flange, metal

Dimensional drawing  
**TH -MS/xx**

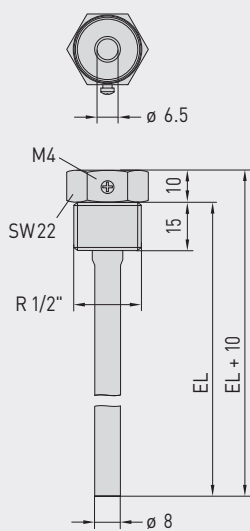

Dimensional drawing  
**TH -VA/xx**

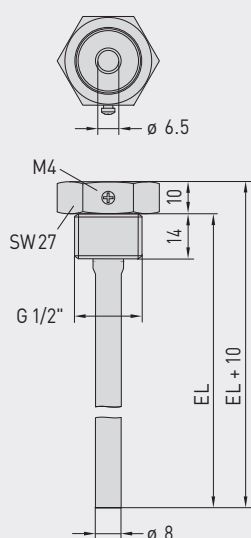

Dimensional drawing  
**TH -VA/xx/90**

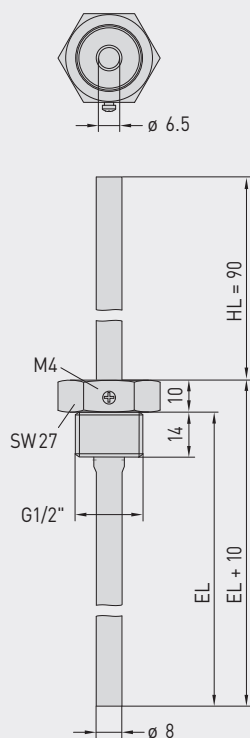

Dimensional drawing  
**MF-06-M**

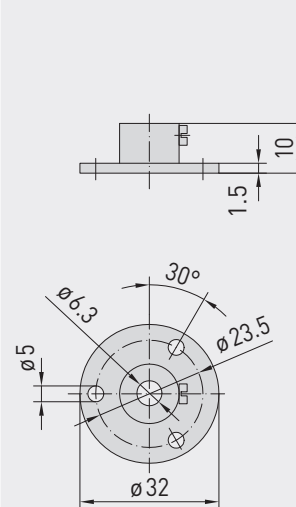



...through combination with accessories:



**TH-MS/xx**  
Immersion sleeve,  
brass, nickel-plated / galvanised,  
thread-sealing, conical,  
according to DIN 10226



**TH-VA/xx**  
Immersion sleeve,  
stainless steel, V4A,  
flat-sealing, cylindrical,  
according to DIN 228



**TH-VA/xx/90**  
Immersion sleeve with neck tube,  
stainless steel, V4A,  
flat-sealing, cylindrical,  
according to DIN 228



**MF-06-M**  
Mounting flange,  
metal

THERMASGARD® TH Immersion sleeve Ø 8 mm (accessories)					
Type / WG01	p <sub>max</sub> (static)	T <sub>max</sub>	Inserted Length (EL)	Item No.	Price
<b>TH-MS/xx</b>	<b>Brass nickel-plated / galvanised</b>			without neck tube	
TH-MS 50MM	10 bar	+150 °C	50 mm	7100-0011-0010-001	10,27 €
TH-MS 100MM	10 bar	+150 °C	100 mm	7100-0011-0020-001	11,71 €
TH-MS 150MM	10 bar	+150 °C	150 mm	7100-0011-0030-001	12,36 €
TH-MS 200MM	10 bar	+150 °C	200 mm	7100-0011-0040-001	12,76 €
TH-MS 250MM	10 bar	+150 °C	250 mm	7100-0011-0050-001	14,77 €
TH-MS 300MM	10 bar	+150 °C	300 mm	7100-0011-0060-001	15,18 €
TH-MS 350MM	10 bar	+150 °C	350 mm	7100-0011-0070-001	15,31 €
TH-MS 400MM	10 bar	+150 °C	400 mm	7100-0011-0080-001	15,45 €
<b>TH-VA/xx</b>	<b>Stainless steel, V4A (1.4571)</b>			without neck tube	
TH-VA 50MM	40 bar	+600 °C	50 mm	7100-0012-0010-001	22,38 €
TH-VA 100MM	40 bar	+600 °C	100 mm	7100-0012-0020-001	24,72 €
TH-VA 150MM	40 bar	+600 °C	150 mm	7100-0012-0030-001	26,56 €
TH-VA 200MM	40 bar	+600 °C	200 mm	7100-0012-0040-001	28,01 €
TH-VA 250MM	40 bar	+600 °C	250 mm	7100-0012-0050-001	34,81 €
TH-VA 300MM	40 bar	+600 °C	300 mm	7100-0012-0060-001	36,38 €
TH-VA 350MM	40 bar	+600 °C	350 mm	7100-0012-0070-001	36,63 €
TH-VA 400MM	40 bar	+600 °C	400 mm	7100-0012-0080-001	37,27 €
<b>TH-VA/xx/90</b>	<b>Stainless steel, V4A (1.4571)</b>			with neck tube (90 mm)	
TH-VA 50/90MM	40 bar	+600 °C	50 mm	7100-0012-2010-001	32,04 €
TH-VA 100/90MM	40 bar	+600 °C	100 mm	7100-0012-2020-001	33,49 €
TH-VA 150/90MM	40 bar	+600 °C	150 mm	7100-0012-2030-001	35,13 €
TH-VA 200/90MM	40 bar	+600 °C	200 mm	7100-0012-2040-001	36,63 €
TH-VA 250/90MM	40 bar	+600 °C	250 mm	7100-0012-2050-001	38,38 €
TH-VA 300/90MM	40 bar	+600 °C	300 mm	7100-0012-2060-001	41,60 €
Note:	inner diameter of socket 6.5 mm For further information see last chapter!				
<b>Mounting flange (accessories)</b>					
Type / WG01		T <sub>max</sub>		Item No.	Price
<b>MF</b>					
<b>MF-06-M</b>	<b>Mounting flange, metal (galvanised steel) Ø 32 mm, tube gland Ø 6.3 mm</b>	+700 °C		7100-0030-5000-100	13,87 €
Note:	For further information see last chapter!				