

# Operating instructions

## RYMASKON® 1000 Controller

Controller to control and regulate temperature, fans,  
light and sun protection (2 zones)

Room control unit with colour TFT display and capacitive keys (touch keys),  
with Modbus connection or (Wireless)



**TABLE OF CONTENTS**

Abbreviations .....	004
Installation and commissioning .....	004
Important notes, safety notes .....	005
Modbus installation .....	006
W-Modbus installation .....	007
<b>UNIT DATA</b>	
Core features, introduction .....	008
Technical data .....	009
Basic models .....	010
Dimensional drawing .....	010
Connection diagrams .....	011
Number keys .....	012
Type table .....	013
<b>CONFIGURATION</b>	
1.0 Configuration, general information .....	014
1.1 Configuration menu (display) .....	014
1.2 Configuration software (PC) .....	016
1.3 Configuration register (higher-level system) .....	016
1.4 W-Modbus .....	017
1.5 CuRA (Customized Register Assignment) .....	017
1.6 Setting the time (time/date) .....	017
<b>USER INTERFACE</b>	
Icons .....	018
2.0 User interface, general information .....	019
2.1 HMI layout (Human Machine Interface) .....	019
2.2 Screen saver .....	020
2.3 Cleaning mode (key lock for 20 s) .....	021
2.4 Key lock (child lock) .....	021
<b>TEMPERATURE</b>	
3.0 Temp menu, general information (setpoint temperature adjustment) .....	022
3.1 Current temperature .....	023
3.2 Setpoint temperature .....	023
3.3 Operating mode .....	023
3.4 Fan display .....	023
<b>FAN</b>	
4.0 Fan menu, general information (fan adjustment) .....	024
4.1 Number of fan steps .....	025
4.2 Fan operating status .....	025
4.3 Fan label .....	025
4.4 Fan level .....	025
<b>SENSORS</b>	
5.0 Sensor menu, general information (sensor display) .....	026
5.1 Sensor menu configuration .....	027
5.2 Calibrating the internal CO <sub>2</sub> and VOC sensors .....	027
<b>PRESENCE</b>	
6.0 Presence menu, general information (presence change) .....	028
6.1 Presence status .....	029
<b>DIGITAL INPUTS &amp; HEADER ICONS</b>	
7.0 Inputs, general information .....	030
7.1 Inputs as presence contact .....	030
7.2 Inputs as contact for header icons .....	030
7.3 Header Icon/Status .....	031
<b>TOUCH KEY EXTENSION</b>	
8.0 Touch key extension, general information .....	032
8.1 Sun Protect menu (sun protection adjustment) .....	034
8.2 Light menu (light adjustment) .....	036

## TABLE OF CONTENTS

Continuation

### CONTROLLER

9.0 Controller general information .....	038
Heating or cooling mode, control loops .....	038
Comfort mode, Eco mode .....	039
Presence, standby .....	039
(Anti-Jam) valve protection .....	040
Underfloor Heat Protection Limit .....	040
Minimum runtime, delay (heat pump function) .....	040
9.1 Temperature setpoint (main control loop) .....	041
Controller Setpoint Temp .....	041
Dead band .....	041
Building protection (Frost Protection and Heat Protection) .....	041
9.2 Change-Over .....	042
9.3 Dew point and window contact .....	043
9.4 Temperature control .....	043
9.4.1 Main control loop (temperature controller) .....	043
9.4.2 Second control loop (temperature controller) .....	048
9.5 Fan control .....	052
9.5.1 Heating/cooling fan control (Fancoil, Auto) .....	053
9.5.2 Fan control RCV (Auto) .....	055
9.6 Outputs .....	060
9.6.1 Heating/cooling output (AO / DO / RO) .....	061
9.6.2 Fan output (AO) .....	061
9.6.3 Output 6-Way Valve (AO) .....	062
9.7 Time program .....	064

## ABBREVIATIONS

<b>AO</b> .....	Analogue Output (0-10 V)
<b>DI</b> .....	Digital Input
<b>DO</b> .....	Digital Output 24 V
<b>dt</b> .....	Controller Sampling Interval
<b>dT<sub>2</sub></b> .....	Control Deviation of second control loop
<b>dT<sub>F1/F2/F3</sub></b> .....	Fan Switching Thresholds (temperature) when connected to main control loop as 2-point controller (ON/OFF) (only for type RYMASKON 144xC with 3 relays for multi-step fans)
<b>dT<sub>Contr</sub></b> .....	Control Deviation of main control loop
<b>dRCV<sub>F1/F2/F3</sub></b> .....	Fan Switching Thresholds (RH/CO2/VOC content) when connected to RCV control loop as 2-point controller (ON/OFF) (only for type RYMASKON 144xC with 3 relays for multi-step fans)
<b>CSC</b> .....	Colour Scale (sensors)
<b>BMS</b> .....	Building Management System
<b>GUI</b> .....	Graphical User Interface
<b>HMI</b> .....	Human Machine Interface
<b>I</b> .....	Integral component PI of control loop
<b>PWM</b> .....	Pulse Width Modulation
<b>RCV</b> .....	RH/CO2/VOC control
<b>RO</b> .....	Digital Output 230 V
<b>T<sub>2,Current</sub></b> .....	Current Temperature of second control loop
<b>T<sub>2,Setpoint</sub></b> .....	Setpoint Temperature of second control loop
<b>T<sub>Current</sub></b> .....	Current Temperature of main control loop
<b>T<sub>1</sub></b> .....	Time Integral
<b>T<sub>Setpoint Contr</sub></b> .....	Setpoint Controller of main control loop
<b>X<sub>p</sub></b> .....	Proportional Range of PI controller
<b>Y<sub>2</sub></b> .....	Manipulated Variable Heating / Cooling of second control loop
<b>Y<sub>calculated</sub></b> .....	Calculated Manipulated Variable
<b>Y<sub>H</sub> / Y<sub>C</sub></b> .....	Manipulated Variable Heating / Cooling of main control loop
<b>Y<sub>F</sub></b> .....	Manipulated Variable Fan coupled to main control loop (Fancoil)
<b>Y<sub>RCV</sub></b> .....	Manipulated Variable Fan for RH/CO2/VOC control (RCV)

## INSTALLATION AND COMMISSIONING

Commissioning is mandatory and may only be performed by qualified personnel!  
 Please read these instructions prior to installation and commissioning,  
 and comply with the specifications that they contain!

Installation must take place while observing all relevant regulations and standards (e.g. such as welding regulations, etc.) applicable at the place where the measurement is taken.  
 It is very important to comply with the following:

- VDE / VDI technical temperature measurements, directives, measurement set-ups for temperature measurements
- EMC directives
- It is imperative to avoid parallel routing of power cables
- We recommend the use of shielded cables with the shielding attached to the DDC / SPS at one side.

Before installing, make sure that the existing technical parameters of the measuring instrument comply with the actual conditions at the place of utilisation, especially:

- Measuring range
- Maximum permissible temperature and humidity
- Protection type and protection class
- Oscillation, vibrations and impacts must be avoided (< 0,5 g)

## IMPORTANT NOTES

Only the valid edition of our conditions and the valid “General Conditions for the Supply of Products and Services of the Electrical and Electronics Industry”(ZVEI conditions) and the supplementary clause “Extended Retention of Title” apply as the General Terms and Conditions regulating this purchase.

The following points must also be complied with:

- These instructions must be read before installation and commissioning, and all of the specifications that they contain must be complied with!
- This unit must only be used for its intended purpose, whereby the applicable VDE safety regulations and all regulations issued by the regional and national regulatory authorities, TÜV and local energy providers must be complied with. The purchaser must ensure that the relevant building and safety regulations are complied with, and must avoid hazards of all kinds.
- No warranty or liability claims whatsoever will be accepted for defects and damage arising from improper use of this unit.
- The warranty and liability excludes consequential damage caused by a fault in this unit.
- The units must only be installed and commissioned by qualified personnel.
- Only the technical data and connecting conditions specified by the installation and operating instructions which are included in the scope of delivery of the unit apply. Deviations from the depictions contained in the catalogue are not additionally listed, and are possible as a result of technical progress and the continuous improvement of our products.
- Any alterations made to the unit by the user will void the warranty.
- This unit must not be installed close to sources of heat (e.g. radiators) or their heat flow. Avoid direct solar irradiation or heat radiation from similar sources (powerful lamps, halogen spotlights).
- Operating this unit close to other units that do not comply with EMC directives may influence functionality.
- This unit must not be used for monitoring purposes which serve to protect persons against hazards or injury, as an Emergency Stop switch on systems or machinery, or for any other similar safety-related purposes.
- The housing dimensions and the dimensions of accessories may differ slightly from the specifications of these instructions.
- Changes to these documents are not permitted.
- In cases of complaint, we will only accept complete units returned in their original packaging.
- A circuit breaker for the unit must be provided nearby where the user can easily reach it. The circuit breaker must be labelled as a disconnecting unit for the appliance.



### Safety instructions for units with a supply voltage of 24 V AC/DC

- The units must only be connected to an extra-low safety voltage in a de-energised condition. To avoid damaging the unit and prevent faults (e.g. due to voltage induction), use shielded cables, avoid laying them parallel to power cables and observe the EMC directives.
- If power supplies with an output power greater than 15 W are used, additional safety measures (circuit breakers) must be implemented to limit the power output in the event of a fault.
- Commissioning is mandatory and may only be performed by qualified personnel!
- The unit must be operated with power supplied from an approved SELV (Safety Extra Low Voltage) or PELV (Protective Extra Low Voltage) power supply unit with limited rated power up to max. 25 W or with its own 1 A back-up fuse 1 A.



### Safety instructions for units with a supply voltage of 230 V AC (100-240V AC)

- The units must only be connected in a de-energised condition. To avoid damaging the unit and prevent faults (e.g. due to voltage induction), use shielded cables, avoid laying them parallel to power cables and observe the EMC directives.
- Commissioning is mandatory and may only be performed by qualified personnel!
- Minimum cross section of 1 mm<sup>2</sup>/AWG 18, Temperature range –40 °C to +60 °C, 3 A fuse, cable type acc. to UL 719/VDE 0250-204



### CAUTION!

**Danger of electric shock! The housing may contain live parts. Particularly with units in mains voltage operation (usually between 90V and 265V), touching live parts may result in personal injury.**

**INSTALLATION**

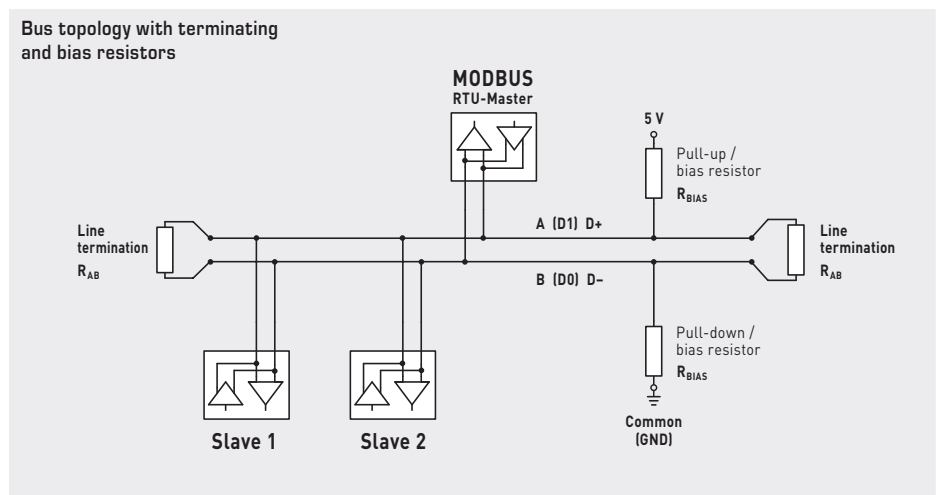
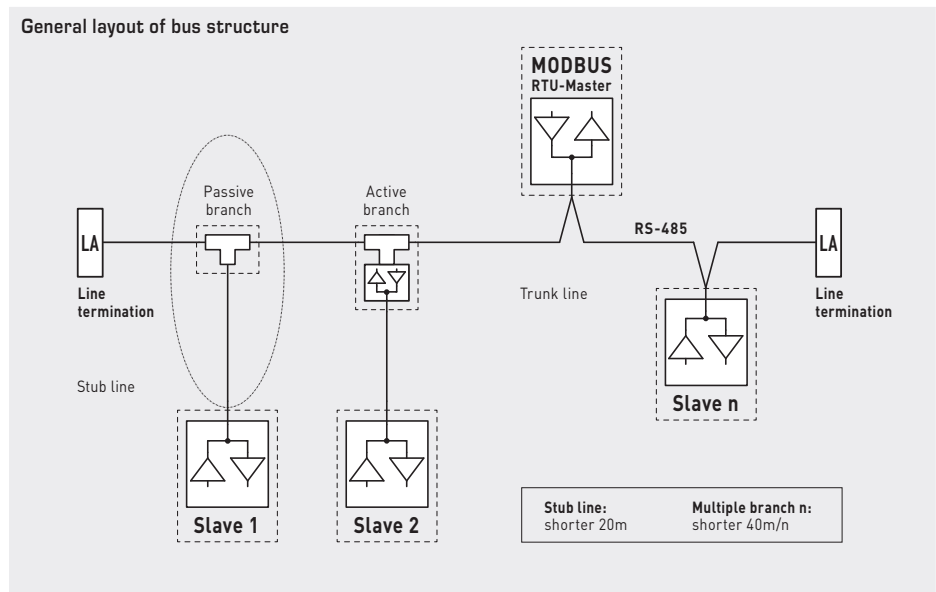

**Terminating resistors** may only be installed at the ends of the bus line.

If necessary, the **LA-Modbus** (separate accessory) can be used as a terminating resistor for **RYMASKON**. No more than two line terminators are permitted in networks without repeaters.

The **bias resistors** for bus level definition in the resting state are usually activated at the Modbus master/repeater.

The maximum **number of subscribers** per Modbus segment is 32 units.

With a greater number of subscribers, the bus must be subdivided into several segments separated by repeaters. The subscriber address can be set from 1 to 247.

A cable with a twisted-pair data line/power supply line and copper shielding braid must be used for the **bus line**. The line capacitance must be less than 100 pF/m (e.g. Profibus cable).

**INSTALLATION**

**W-Modbus** 

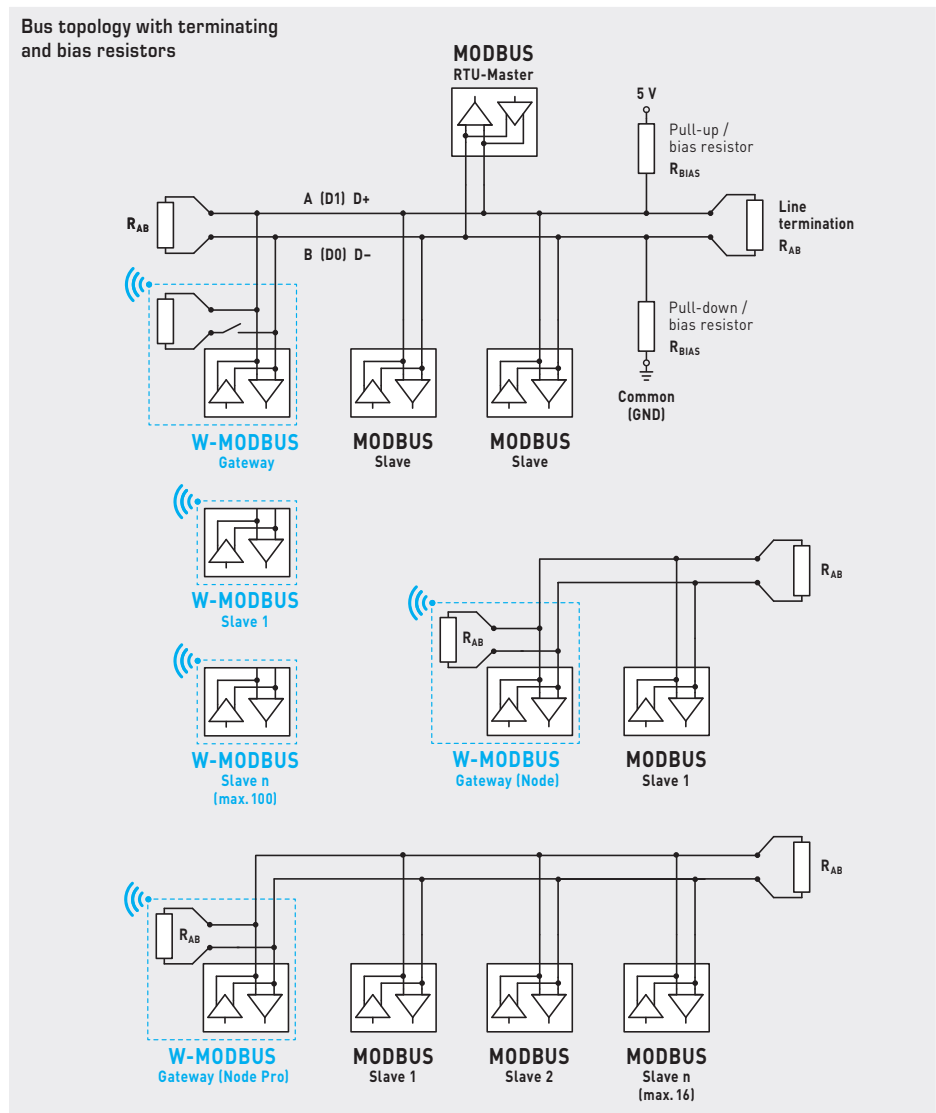

The **W-Modbus protocol** is based on the 2.4 GHz ISM radio band and employs patented frequency hopping technology to maximise reliability and resistance to interference. This means that reliable radio transmission can also be ensured in industrial environments.

In the **W-Modbus network**, up to 100 nodes can communicate with each other over a long distance (up to 500 m in an open field) using one gateway. A standardised W-Modbus module ensures compatibility with all W-Modbus units.

The **W-Modbus sensors** only need to be supplied with power. Only the slave address and the transmission parameters (baud rate and parity) are set automatically. No terminating resistor is necessary. The sensor is then paired with a gateway.

The **W-Modbus-gateway** serves as a transition between wired Modbus and radio-based W-Modbus. Even mixed configurations of wired and radio-based Modbus units can be easily integrated into existing network topologies via the W-Modbus gateway.

S+S Regeltechnik GmbH hereby declares that the radio equipment type **RYMASKON® 1000 Controller W-Modbus (WMOD)** complies with the Directive 2014/53/EU. The full text of the EU Declaration of Conformity can be found at the following Internet address: [www.spluss.de/RYM13111W220000/](http://www.spluss.de/RYM13111W220000/)

## KEY FEATURES

Basic models  
(see type table)



- 24 V AC/DC voltage supply or 230 V AC
- **Modbus** connection or wireless **W-Modbus**
- 2.0" TFT **display** (320 x 240 x 3 RGB pixels), with LED backlighting, high contrast, 85° viewing angle
- Capacitive keys (touch keys)  
(optional extension, see number key pos. 14-15)
- **Housing** Iduna 3 (112 x 89.5 x 24 mm), white and black colours, for wall-mounting on in-wall flush boxes, quick and easy installation via push-in terminals
- Integrated temperature and humidity sensor (basic equipment)  
(additional sensors optional: CO<sub>2</sub>, VOC)
- **Control** of heating, cooling, 6-way valve, fan
- **Control** of temperature, fan  
(sun protection and light with dimming function available as an option)
- Power-saving and environmentally friendly thanks to **features** such as brightness adjustment, stand-by, wake-up, etc.
- **CuRA** (Customized Register Assignment)  
Assignment of individual register addresses for each data point

## DESCRIPTION

### Introduction

The room control units of the **RYMASKON® 1000 / 2000 / 3000** series are designed for control (up to 5 climate zones) in residential, hotel and office rooms and individually regulate the heating, cooling and fan levels of the internal rooms. The controller variants can be operated as stand-alone units thanks to the integrated control functions PI, PWM or 2-/3-point control. The product family is characterised by its elegant design, intuitive operation and the many possible combinations of the individual components.

The room control units **RYMASKON® 1000C** (Controller) are used to control and regulate heating convectors and fan coils. Depending on the type variant, the units are available with analogue outputs (0-10V) and with Digital/relay outputs for controlling heating valves, cooling valves, 6-way valves, staged fans or EC fans. Control takes place via PI, PWM or 2-point/3-point control. The change-over function can be used to operate 2-pipe and 4-pipe systems. The Modbus or W-Modbus communication interface enables the climate parameters on the controller to be changed and monitored via the BMS at any time. In addition, the sun protection (Venetian blinds, shutters) and light (with dimming function) functions can be controlled via the bus. Visual indication takes place on a 2" TFT **display**, where as the unit is controlled via capacitive keys (**touch keys**).

In addition to the integrated temperature and humidity sensor, **sensors** for CO<sub>2</sub> and VOC are available as an option. An input for a passive temperature sensor (NTC10K) and an input for a potential-free contact are additionally available. This allows a window contact or a condensation control switch to be connected, for example. This provides all options for air-conditioning of the rooms according to individual requirements.

All unit types are available in the contemporary **housing** Iduna 3 (112 x 89.5 x 24 mm) in white or black colour. Wall-mounting is performed on standard in-wall flush boxes.



## DESCRIPTION

Technical data  
 (Rev. Data-V34)

TECHNICAL DATA	
Unit type:	Room controller for heating convectors or fan coils
Functions:	Temperature, fan, sun protection and light (see type table)
System of units:	SI (default) or imperial (can be changed in the Modbus register)
Data points:	Temperature [°C] [°F], relative humidity [%RH], air quality (VOC) [%] [ppb], carbon dioxide (CO <sub>2</sub> ) [ppm], setpoint (temperature, fan, presence)
Power consumption:	typically < 3 W at 24 V DC; < 4.5 VA at 24 V AC; < 6.5 VA at 230 V AC
Voltage supply:	24 V AC/DC (± 10 %) or 230 V AC (100-240 V AC)
Communication:	<b>Modbus</b> (RTU cable), Slave, address range 1...247, max. 32 units, RS 485 interface, <b>galvanically isolated</b> , 9600 / 19200 / 38400 / 57500 Baud, 8N1, even / odd parity, 1 / 2 stop bits or <b>W-Modbus</b> (Wireless Modbus, AES-128 encrypted), Frequency <b>2.4 GHz</b> ISM, Transmission power <b>100 mW</b> , Range <b>max. 500 m</b> (open field) / approx. 50 - 70 m (inside buildings), Slave, address range 1...247, max. 100 units on one gateway, BMS connection is radio-based via W-Modbus gateway
Display:	<b>TFT display</b> , 2" (41 x 30 mm), 320 x 240 x 3 pixels (RGB), LED backlighting, viewing angle ± 85°
Operating elements:	<b>capacitive keys</b> (up to 10 keys, depending on type) for setting the target temperature, fan stages, presence message, sensor values, and for operating sun protection and light
Inputs:	1 Input <b>NTC10K</b> (can be configured as a digital input <b>DI1</b> , potential-free) 1 Digital input <b>DI2</b> for potential-free switches (24 V devices) or for potential-loaded switch (230 V devices)
Outputs:	<b>Analogue Outputs AO</b> (0-10 V DC, max. 5 mA) as <b>PI controllers</b> <b>Relay Outputs RO</b> (230 V AC, max. 500 mA, cos φ = 1.0/resistive load) or (230 V AC, max. 3 A, cos φ = 1.0/resistive load) as <b>2-point/3-point controllers</b> <b>Digital Outputs DO</b> (I <sub>n</sub> 400 mA, short circuit max. 1.2 A) as <b>2-point/3-point controllers, PWM</b> for heating/cooling, 6-way valves, fan, number depends on controller type (see connection diagrams)
Electrical connection:	0.2 - 1.5 mm <sup>2</sup> , using push-in terminals
Housing:	plastic, <b>flame retardant</b> (UL 94 V-0), PC/ABS material, colour <b>white</b> (similar to RAL 9016) or <b>black</b> (similar to RAL 9004)
Housing dimensions:	112 x 89.5 x 24 mm (W x H x D) (Iduna 3) in-wall: + 23 mm (D), sensor protection: + 22 mm (H)
Mounting:	Wall-mounting on in-wall flush box, Ø 55 mm
Ambient temperature:	0...+50 °C (operation); -30...+70 °C (storage)
Permitted humidity:	0...90 % RH (non-precipitating air)
Protection type:	IP 30 (according to EN 60 529)
Overvoltage category:	OVC1 (at 24V); OVC2 (at 230 V)
Contamination degree:	PD2
Standards:	CE conformity according to Low-Voltage Directive 2014/35/EU, EMC Directive 2014/30/EU (Modbus) or Radio Equipment Directive 2014/53/EU (W-Modbus)
<b>TEMPERATURE</b>	(basic equipment)
Sensor:	digital temperature sensor, low hysteresis, high long-term stability
Measuring range:	0...+50 °C / +32...+122 °F
Accuracy:	typically ± 0.3 K / ± 0.5 °F at +25 °C / +77 °F
<b>HUMIDITY</b>	(basic equipment)
Sensor:	digital humidity sensor, low hysteresis, high long-term stability
Measuring range:	0...100 % RH
Accuracy:	typically ± 2.0 % (20...80 % RH) at +25 °C / +77 °F, otherwise ± 3.0 %
<b>CARBON DIOXIDE (CO<sub>2</sub>)</b>	(optional)
Sensor:	digital photoacoustic NDIR-CO <sub>2</sub> sensor (non-dispersive infra-red technology), with automatic calibration and high long-term stability
Measuring range:	0...2000 ppm
Accuracy:	typically ± 50 ppm, ± 3 % of the measured value at +25 °C / +77 °F
<b>AIR QUALITY (VOC)</b>	(optional)
Sensor:	digital metal oxide (MOX) based VOC sensor
Measuring range:	0...100 % (corresponds to IAQ Index 1...500 or 0...2383 ppb ethanol equivalent – non-linear)
Accuracy:	< ± 15 %
Service life:	> 10 years (if used as intended, depending on type and duration of VOC exposure)

**BASIC MODELS**



Room control units  
 for temperature  
 adjustment



Type 1311 / 1321 / 1361



Type 1312 / 1322 / 1362



Room control units  
 for temperature and  
 fan adjustment



Type 1431 / 1441 / 1451 / 1461



Type 1432 / 1442 / 1452 / 1462

**DIMENSIONAL DRAWING**

Housing Iduna 3 (UP)  
 [mm]

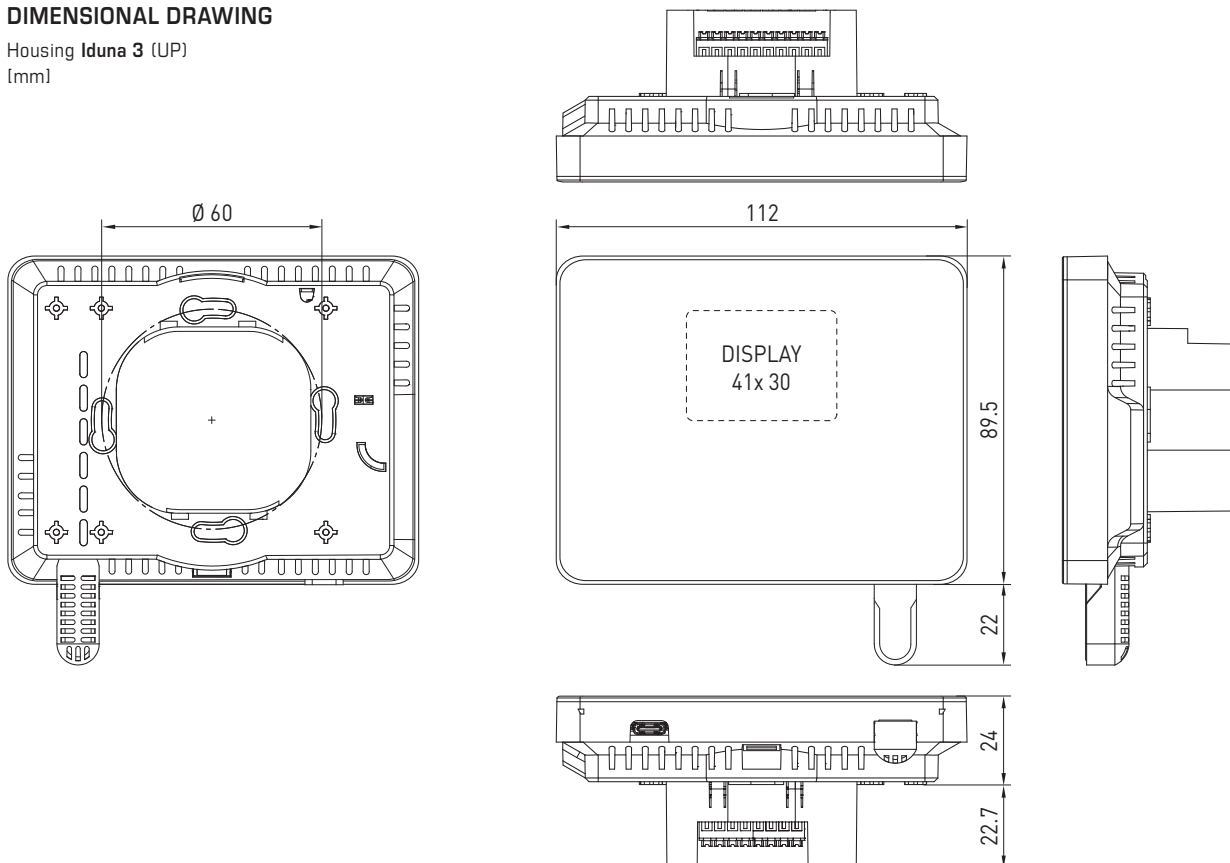

**Type 132xC-MOD**  
24 V

3 AO (h, c, 6W)

- 1 free
- 2 free
- 3 free
- 4 free
- 5 **A03** 0-10V (6-way valve)
- 6 **A02** 0-10V (cooling)
- 7 **A01** 0-10V (heating)
- 8 GND (AO)
- 9 GND (DI2)
- 10 **DI2** (potential-free)
- 11 **UB+** 24V AC/DC
- 12 **UB-** GND AC/DC
- 13 **NTC10K (DI1, potential-free)**
- 14 GND (NTC10K/DI1)
- 15 Modbus A
- 16 Modbus B
- 17 Modbus A
- 18 Modbus B

**Type 143xC-MOD**  
24 V

2 AO (h, c, 6W) + 1 AO (f)

- 1 free
- 2 free
- 3 free
- 4 free
- 5 **A03** 0-10V (fan)
- 6 **A02** 0-10V (cooling, 6-way valve)
- 7 **A01** 0-10V (heating, 6-way valve)
- 8 GND (AO)
- 9 GND (DI2)
- 10 **DI2** (potential-free)
- 11 **UB+** 24V AC/DC
- 12 **UB-** GND AC/DC
- 13 **NTC10K (DI1, potential-free)**
- 14 GND (NTC10K/DI1)
- 15 Modbus A
- 16 Modbus B
- 17 Modbus A
- 18 Modbus B

**Type 136xC-MOD**  
**Type 146xC-MOD**  
24 V

2 AO (h, c) / (f) + 2 DO (h, c)

- 1 **DO2** (NO contact, 400mA, cooling)
- 2 **DO1** (NO contact, 400mA, heating)
- 3 Root/COM (24V, max. 1A res. load)
- 4 free
- 5 free
- 6 **A02** 0-10V (cooling) / (fan)
- 7 **A01** 0-10V (heating) / (fan)
- 8 GND (AO)
- 9 GND (DI2)
- 10 **DI2** (potential-free)
- 11 **UB+** 24V AC/DC
- 12 **UB-** GND AC/DC
- 13 **NTC10K (DI1, potential-free)**
- 14 GND (NTC10K/DI1)
- 15 Modbus A
- 16 Modbus B
- 17 Modbus A
- 18 Modbus B

**Type 132xC-WMOD**  
24 V

3 AO (h, c, 6W)

- 1 free
- 2 free
- 3 free
- 4 free
- 5 **A03** 0-10V (6-way valve)
- 6 **A02** 0-10V (cooling)
- 7 **A01** 0-10V (heating)
- 8 GND (AO)
- 9 GND (DI2)
- 10 **DI2** (potential-free)
- 11 **UB+** 24V AC/DC
- 12 **UB-** GND AC/DC
- 13 **NTC10K (DI1, potential-free)**
- 14 GND (NTC10K/DI1)
- 15 free
- 16 free
- 17 free
- 18 free

**Type 143xC-WMOD**  
24 V

2 AO (h, c, 6W) + 1 AO (f)

- 1 free
- 2 free
- 3 free
- 4 free
- 5 **A03** 0-10V (fan)
- 6 **A02** 0-10V (cooling, 6-way valve)
- 7 **A01** 0-10V (heating, 6-way valve)
- 8 GND (AO)
- 9 GND (DI2)
- 10 **DI2** (potential-free)
- 11 **UB+** 24V AC/DC
- 12 **UB-** GND AC/DC
- 13 **NTC10K (DI1, potential-free)**
- 14 GND (NTC10K/DI1)
- 15 free
- 16 free
- 17 free
- 18 free

**Type 136xC-WMOD**  
**Type 146xC-WMOD**  
24 V

2 AO (h, c) / (f) + 2 DO (h, c)

- 1 **DO2** (NO contact, 400mA, cooling)
- 2 **DO1** (NO contact, 400mA, heating)
- 3 Root/COM (24V, max. 1A res. load)
- 4 free
- 5 free
- 6 **A02** 0-10V (cooling) / (fan)
- 7 **A01** 0-10V (heating) / (fan)
- 8 GND (AO)
- 9 GND (DI2)
- 10 **DI2** (potential-free)
- 11 **UB+** 24V AC/DC
- 12 **UB-** GND AC/DC
- 13 **NTC10K (DI1, potential-free)**
- 14 GND (NTC10K/DI1)
- 15 free
- 16 free
- 17 free
- 18 free

**Type 131xC-WMOD**  
230 V

2 RO (h, c) + 1 AO (6W)

- 1 free
- 2 free
- 3 free
- 4 **R01** Heating relay (solid state, 0.5A)
- 5 **R02** Cooling relay (solid state, 0.5A)
- 6 **DI2** (230V AC) - Ref N
- 7 **N** (230V AC)
- 8 **L** (230V AC)
- 11 Output 0-10V (6-way valve)
- 12 GND (Output 0-10V)
- 13 **NTC10K (DI1, potential-free)**
- 14 GND (NTC10K/DI1)

**Type 145xC-WMOD**  
230 V

2 RO (h, c) + 1 AO (f)

- 1 free
- 2 free
- 3 free
- 4 **R01** Heating relay (solid state, 0.5A)
- 5 **R02** Cooling relay (solid state, 0.5A)
- 6 **DI2** (230V AC) - Ref N
- 7 **N** (230V AC)
- 8 **L** (230V AC)
- 11 Output 0-10V (Fan)
- 12 GND (Output 0-10V)
- 13 **NTC10K (DI1, potential-free)**
- 14 GND (NTC10K/DI1)

**Type 144xC-WMOD**  
230 V

2 RO (h, c) + 3 RO (f)

- 1 **R03 Fan level 1** relay (mechanical, 3A)
- 2 **R04 Fan level 2** relay (mechanical, 3A)
- 3 **R05 Fan level 3** relay (mechanical, 3A)
- 4 **R01** Cooling relay (solid state, 0.5A)
- 5 **R02** Heating relay (solid state, 0.5A)
- 6 **DI2** (230V AC) - Ref N
- 7 **N** (230V AC)
- 8 **L** (230V AC)
- 11 free
- 12 free
- 13 **NTC10K (DI1, potential-free)**
- 14 GND (NTC10K/DI1)

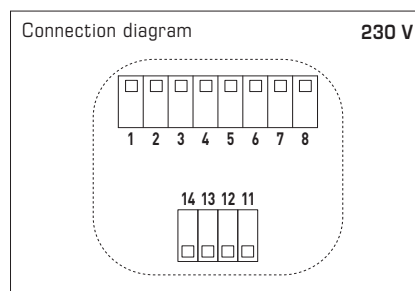
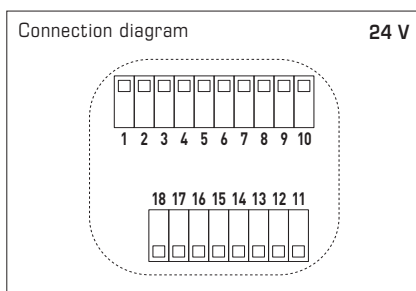

**WARNING:**  
Turn off the power before starting wiring!



**RYMASKON® 1000 C Controller (series)**  
 Number key for type versions

**RYM1**-X X X 1-X X X 0-0 X X

<b>Pos. 1-4</b>	<b>Type name</b> RYMASKON 1000 C	RYM1
<b>Pos. 5-6</b>	<b>Controller type</b> Setpoint adjustment   outputs  Temperature	
	[1] 2 RO (h,c) + 1 AO (6W)	*1 31
	[2] 3 AO (h,c, 6W)	32
	[3] 2 AO (h,c) + 2 DO (h,c)	36
	Temperature + Fan	
	[4] 2 AO (h,c, 6W) + 1 AO (f)	43
	[5] 2 RO (h,c) + 3 RO (f)	*1 44
	[6] 2 RO (h,c) + 1 AO (f)	*1 45
	[7] 2 AO (h,c, f) + 2 DO (h,c)	46
<b>Pos. 7</b>	<b>Housing colour</b> White Black	1 2
<b>Pos. 8</b>	<b>Visual indication</b> TFT display (2.0")	1
<b>Pos. 9</b>	<b>Communication</b> Modbus W-Modbus (Wireless)	*2 M W
<b>Pos. 10</b>	<b>Sensors</b> T [°C/°F], RH [%] T [°C/°F], RH [%], CO2 [ppm] T [°C/°F], RH [%], VOC [%] T [°C/°F], RH [%], CO2 [ppm], VOC [%]	2 6 7 8
<b>Pos. 11</b>	<b>Voltage supply</b> 24 V AC/DC 230 V AC	1 2
<b>Pos. 12</b>	<b>Mounting</b> on in-wall flush box, Ø55 mm	0
<b>Pos. 14-15</b>	<b>Touch key extension</b> *3  Basic model (cf. <b>Pos. 5</b> ) including room occupancy + <b>B</b> (1 sun protection) + <b>BB</b> (2 sun protection) + <b>L</b> (1 light) + <b>LL</b> (2 light) + <b>LB</b> (1 light, 1 sun protection)	00 01 02 03 04 05

*1 230 V units	<b>Outputs</b>	<b>Sensors</b>
*2 Not with 230 V units	<b>AO</b> Analogue (0-10 V DC)	<b>T</b> Temperature [°C/°F]
*3 Adjustment of sun protection ( <b>B</b> ) and light ( <b>L</b> ) is only possible via bus	<b>RO</b> Relay (230 V AC)	<b>RH</b> Relative humidity [%]
	<b>DO</b> Digital (24 V DC)	<b>CO2</b> Carbon dioxide [ppm]
	(h,c) Heating, Cooling	<b>VOC</b> Air quality [%]
	(f) Fan	
	(6 W) 6-way valve	

<b>RYMASKON® 13xx C</b>		Controller (basic model) for heating convectors (HC) for temperature adjustment					
Type / WG02 Control outputs	Communi- cation	Measuring element	Control system	Colour / Housing	Display	Item no.	
<b>[1] 2 RO (heating, cooling, 230 V AC, max. 500 mA) + 1 AO (6-way valve, 0-10 V)</b>							
<b>RYMASKON® 131x C</b>				<b>Iduna 3</b>			
RYM 1311C-RH-WMOD	W-Modbus	T   RH	T   -   R	white	■	RYM1-3111-W220-000	
RYM 1312C-RH-WMOD	W-Modbus	T   RH	T   -   R	black	■	RYM1-3121-W220-000	
<b>[2] 3 AO (heating, cooling, 6-way valve, 0-10 V)</b>							
<b>RYMASKON® 132x C</b>				<b>Iduna 3</b>			
RYM 1321C-RH-MOD	Modbus	T   RH	T   -   R	white	■	RYM1-3211-M210-000	
RYM 1322C-RH-MOD	Modbus	T   RH	T   -   R	black	■	RYM1-3221-M210-000	
RYM 1321C-RH-WMOD	W-Modbus	T   RH	T   -   R	white	■	RYM1-3211-W210-000	
RYM 1322C-RH-WMOD	W-Modbus	T   RH	T   -   R	black	■	RYM1-3221-W210-000	
<b>[3] 2 AO (heating, cooling, 0-10V) + 2 DO (heating, cooling, 24 V, max. 1 A resistive load)</b>							
<b>RYMASKON® 136x C</b>				<b>Iduna 3</b>			
RYM 1361C-RH-MOD	Modbus	T   RH	T   -   R	white	■	RYM1-3611-M210-000	
RYM 1362C-RH-MOD	Modbus	T   RH	T   -   R	black	■	RYM1-3621-M210-000	
RYM 1361C-RH-WMOD	W-Modbus	T   RH	T   -   R	white	■	RYM1-3611-W210-000	
RYM 1362C-RH-WMOD	W-Modbus	T   RH	T   -   R	black	■	RYM1-3621-W210-000	

<b>RYMASKON® 14xx C</b>		Controller (basic models) for FAN COILS for temperature and fan adjustment					 
Type / WG02 Control outputs	Communi- cation	Measuring element	Control system	Colour / Housing	Display	Item no.	
<b>[4] 3 AO (heating, cooling 6-way valve, EC fan, 0-10 V)</b>							
<b>RYMASKON® 143x C</b>				<b>Iduna 3</b>			
RYM 1431C-RH-MOD	Modbus	T   RH	T   F   R	white	■	RYM1-4311-M210-000	
RYM 1432C-RH-MOD	Modbus	T   RH	T   F   R	black	■	RYM1-4321-M210-000	
RYM 1431C-RH-WMOD	W-Modbus	T   RH	T   F   R	white	■	RYM1-4311-W210-000	
RYM 1432C-RH-WMOD	W-Modbus	T   RH	T   F   R	black	■	RYM1-4321-W210-000	
<b>[5] 5 RO (heating, cooling, 230 VAC, max. 500 mA   3-level fan, 230 VAC, max. 3 A)</b>							
<b>RYMASKON® 144x C</b>				<b>Iduna 3</b>			
RYM 1441C-RH-WMOD	W-Modbus	T   RH	T   F   R	white	■	RYM1-4411-W220-000	
RYM 1442C-RH-WMOD	W-Modbus	T   RH	T   F   R	black	■	RYM1-4421-W220-000	
<b>[6] 2 RO (heating, cooling, 230 VAC, max. 500 mA) + 1 AO (EC fan, 0-10 V)</b>							
<b>RYMASKON® 145x C</b>				<b>Iduna 3</b>			
RYM 1451C-RH-WMOD	W-Modbus	T   RH	T   F   R	white	■	RYM1-4511-W220-000	
RYM 1452C-RH-WMOD	W-Modbus	T   RH	T   F   R	black	■	RYM1-4521-W220-000	
<b>[7] 2 AO (EC fan, 0-10 V) + 2 DO (heating, cooling, 24 V, max. 1 A resistive load)</b>							
<b>RYMASKON® 146x C</b>				<b>Iduna 3</b>			
RYM 1461C-RH-MOD	Modbus	T   RH	T   F   R	white	■	RYM1-4611-M210-000	
RYM 1462C-RH-MOD	Modbus	T   RH	T   F   R	black	■	RYM1-4621-M210-000	
RYM 1461C-RH-WMOD	W-Modbus	T   RH	T   F   R	white	■	RYM1-4611-W210-000	
RYM 1462C-RH-WMOD	W-Modbus	T   RH	T   F   R	black	■	RYM1-4621-W210-000	
Measuring element / control system:	T = Temperature sensor RH = Humidity sensor		T = Temperature F = Fan R = Room occupancy				

<b>OPTIONS</b>		
Measuring elements:	<b>CO2</b> = CO2 sensor	Extra charge
	<b>VOC</b> = VOC sensor	Extra charge
Control:	<b>B / L</b> Keys for sun protection and/or light (cf. <b>Pos. 14-15</b> )	on request
Communication:	without Modbus	on request
Optional:	<b>More type versions on request!</b> For configuration options, see number key (left)	

## CONFIGURATION

General information and configuration menu

[Configuration register](#)

[Save to non-volatile memory \(EEPROM\)](#)  
[SaveToEEPROM\\_2013](#)

[Menu structure](#)  
[Configuration menu](#)

Configuration (Main)

- 1 **Device Info**
  - Serial Number
  - Device type
  - Device ID
  - Manufacturer
  - Operating time
  - SW Version
  - User Manual (QR code)
- 2 **Modbus** *(type-dependent)*
  - Bus Address
  - Baud Rate
  - Parity / Stop Bits
- 2 **W Modbus** *(type-dependent)*
  - Bus Address
  - NW State
  - NW Quality
  - GW Pairing
  - Bluetooth (AppMode)
- 3 **Date / Time**
  - Date Format
  - Date Adjust
  - Time Format
  - Time Adjust
  - Summer Time
- 4 **Factory Reset**
  - confirm
- 5 **Save / Exit**
  - confirm
- 6 **Discard / Exit**
  - confirm

## 1.0 General configuration

The unit can be configured in three ways:

- **Display (unit)**  
 Manual input via Configuration **menu** directly on the unit's display.  
 (RS485 interface configuration)
  - **Configuration Tool (PC)**  
 Input/upload to the unit via PC using configuration **software** (USB-C interface).  
 (Configuration of the RS485 interface and configuration of all other unit parameters)
  - **BMS (Modbus)**  
 Input in Modbus **Register table** via the bus (RS485 interface).  
 (No configuration of the RS485 interface, otherwise configuration of all other unit parameters)
- The configuration parameters are stored permanently in the unit's non-volatile memory. To do this, all changes must be **saved** to the non-volatile memory (EEPROM) using the Save parameter once the configuration is finished.

Configurable Modbus parameters (type-dependent)

Modbus	Value range
Bus address	1 (default) ... 247
Baudrate	9600 / <b>19200</b> (default) / 38400 / 57600 / 115200 baud
Parity / stop bits	NONE (none, 1 stop bit) <b>EVEN</b> (even, 1 stop bit) (default) ODD (odd, 1 stop bit) NONE (none, 2 stop bits)

## 1.1 Configuration menu (Display)

The menu is used to configure the RS485 interface via the unit's display. To navigate the menu structure and edit entries, there are additional functions assigned to the **PRESENCE** (🏠), **SENSOR** (🌡️) keys and the **UP** (↑) and **DOWN** (↓) arrow keys for temperature adjustment (see table).

Key assignment in the configuration menu

🏠	<b>BACK</b>	One level <b>back</b> in the menu structure
	<b>CANCEL</b>	<b>Cancel</b> the ongoing editing
↑ 🌡️ ↓	<b>SELECT</b>	<b>Navigate</b> through the list (up/down)
	<b>VALUE</b>	<b>Change</b> the entry value (increase/decrease)
🌡️	<b>OK</b>	<b>Confirm</b> the entry value
	<b>NEXT</b>	<b>Next</b> menu level or next editing field of the value

Accessing the configuration menu

To access the configuration menu, you have to press and hold down the **SENSOR** (🌡️) key, immediately followed by the **PRESENCE** (🏠) key. **Press both keys together for 3 s** (Fig. 001).

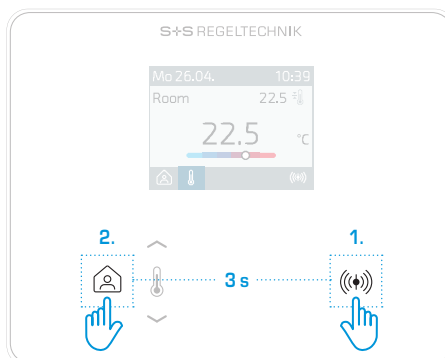

Fig. 001 Accessing the configuration menu

[Configuration register](#)

[PIN config menu](#)  
[PIN\\_2008](#)  
 (Default: 1111)

**Entering the PIN number**

After accessing the configuration menu, you first have to enter a 4-digit **PIN** number (Fig. 002). The number sequence of the PIN can be changed via the Modbus register or the PIN verification can be permanently deactivated (default: 1111 / no PIN: 0000).

The top menu level Device Info (**Main**) then opens with the first entry (Fig. 003).

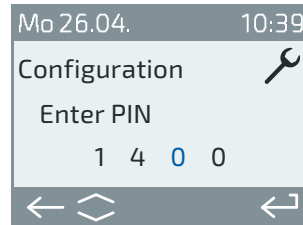

Fig. 002 PIN entry

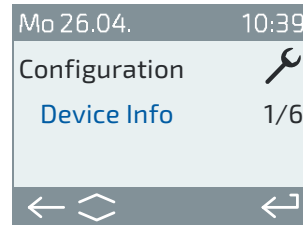

Fig. 003 First entry (Main)

**Confirming a value**

The value of the entry is initially inactive (Fig. 004).

Activation is via the **SENSOR** (☎) key.

The **active value** is then displayed in a **focus colour** (Fig. 005).

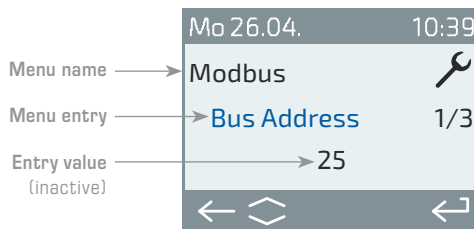

Fig. 004 Editing inactive

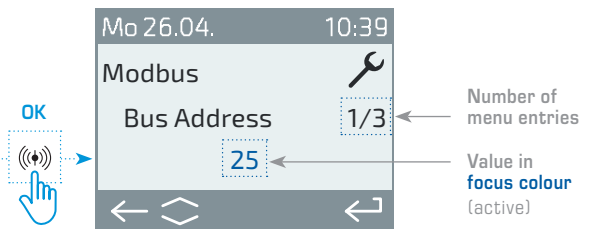

Fig. 005 Active value in focus colour

**Factory reset**

All parameters can be reset in the **Factory Reset** level (Fig. 006).

After confirming with 'Yes', the unit restores the factory settings (bus parameters are retained) and performs a restart (Fig. 007).

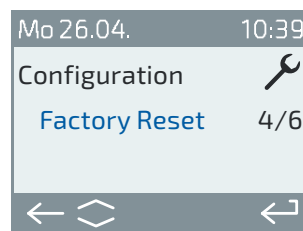

Fig. 006 Accessing factory reset

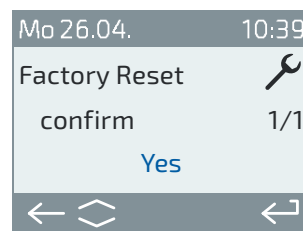

Fig. 007 Factory reset confirmation

**Exiting the configuration**

**Saving** and exiting takes place in the **Safe / Exit** level (Fig. 008).

This way, all entered values are saved permanently.

Exiting **without saving** takes place in the **Discard / Exit** level (Fig. 009).

This **cancels** the configuration and all entries are discarded.

After confirming with 'Yes', the configuration menu closes and the **Home screen** (setpoint temperature adjustment) appears on the display.

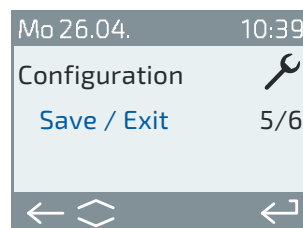

Fig. 008 Saving and exiting

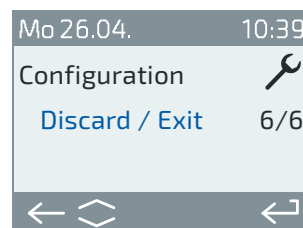

Fig. 009 Exiting without saving

## 1.2 Configuration software (PC)

The PC software **SplusS-ConfigurationTool** is used to configure the RS485 interface and all other unit parameters. It is also possible to save an existing **unit configuration** within the software and **transfer** it to other units. Thanks to the innovative **CuRA**-function (Customised Register Assignment), each data point can be assigned an individual register address (see chapter 1.5).

The software accesses the Modbus structure of the unit and can read (r) or read/write (r/w) all values. The configuration options range from the adjustment range of the set values to the brightness setting of the display and the bus parameters. It will still be possible to input data via the **RS485 interface**.

### System requirements (PC)

Windows operating system:..... Win7 / Win8.x / Win10 / Win11  
System type:..... 32-bit or 64-bit  
CPU:..... 2 GHz  
HD free memory: ..... 100 MB  
Working memory (RAM): ..... min. 1 GB (2 GB for Win11)  
Screen resolution:..... min. 1400 x 1050 pix  
USB connection required!

### Download (exe)

The SplusS-ConfigurationTool can be downloaded online from the download area of the device at <https://www.spluss.de/en/collections/room-controller-rymaskon-controller>

When the program is launched for the first time, **Microsoft Defender** displays a safety notice, which must be confirmed with "Run anyway".

### Unit connection

The unit is connected via the **USB-C**-interface on the underside of its housing (Fig. 010). You can use a commercially available cable for this (not included in the scope of delivery). The unit does not require an additional power supply.

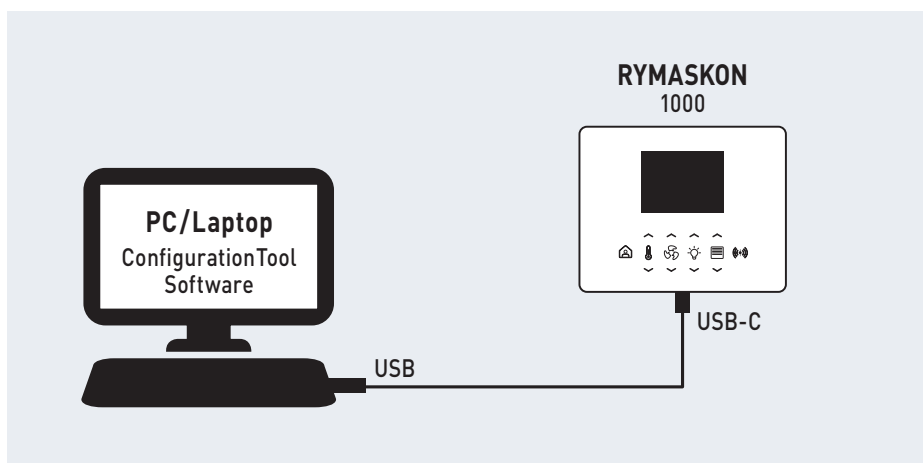

Fig. 010 Connection via USB-C interface

### [Configuration register](#)

*The notes on the side refer to the relevant configuration register.*

*Note: The register address information refers to the original number (not to the favourites list).*

## 1.3 Configuration register (higher-level system)

In addition to the data points that can be used to operate the unit (data register), the unit can also be configured via the Modbus register. Input is made via the BMS (RS485 interface) or by means of the configuration software (PC).

You can find more relevant information in the document 'Modbus register tables' provided in the download area of the device at

<https://www.spluss.de/en/collections/room-controller-rymaskon-controller>



## W-Modbus

### 1.4 W-Modbus

The RYMASKON® 1000 is integrated into a W-Modbus network using the **configuration menu** (refer to chapter 1.1) directly on the unit (display).

#### Network connection

The connection to the W-Modbus gateway is established at the **Pairing** level. Deactivation takes place automatically when you exit the Pairing mode on the master gateway. Even the network **status** and network **quality** can be queried via the menu.

#### W-Modbus App

The Lumenradio W-Modbus App can access W-Modbus units. To do this, **Bluetooth** must first be activated in the configuration menu. The unit then becomes visible for approx. 60 s and can be connected via the app. The connection remains active until you press **'Disconnect'** in the app or activate Pairing on the unit.

The following data is available in app mode:

- Firmware updates of the wireless module
- Error detection (duplicate bus addresses, communication errors, etc.)
- Individual unit names
- Checking the network setup
- Documentation for the network setup (PDF)

You can find more information via the help function in the app. The app is available for Android and Apple mobile devices through the App Store.

**Link for Apple** Lumenradio W-Modbus App:  
<https://apps.apple.com/de/app/w-modbus/id6472275984>

**Link for Android** Lumenradio W-Modbus App:  
<https://play.google.com/store/apps/details?id=com.lumenradio.wmodbus>



### 1.5 CuRA (Customised Register Assignment)

The configuration software **SplusS-ConfigurationTool** can be used to assign an **individual register address** to each data point. The individual address assignment can be saved within the software and transferred to other units.

This simplifies the integration of the unit into an existing building automation system and can be done without reprogramming the BMS.

Furthermore, the **CuRA function** can also be used to create register blocks and thus significantly increase the query speed.

#### [Configuration register](#)

[Time and date](#)  
[Time\\_Format\\_2015](#)  
[Date\\_Format\\_2016](#)  
[Time\\_SetSummerWinter\\_2017](#)

#### [Data register](#)

[Time and date](#)  
[Date\\_Time\\_2018-2023](#)

### 1.6 Time setting (time/date)

The unit has a real-time clock that automatically calculates the **time** and **date**. During commissioning, the time and date must be updated **manually** via the configuration menu (display), via the BMS (Modbus register) or using the configuration software (PC).

The time setting is based on standard time (winter time).

It is possible to activate an **automatic time change** to summer time, if necessary.

The configured time is retained in the event of a temporary power interruption.

### ICONS

Screen areas and explanation of icons

#### DISPLAY / MENU

##### APPEARANCE (configurable)

Display mode (light/dark), brightness, language, units and individual labels can be selected.

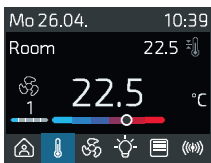

Display Darkmode

##### HOME SCREEN

The default view is the setpoint temperature adjustment with fan levels if necessary.

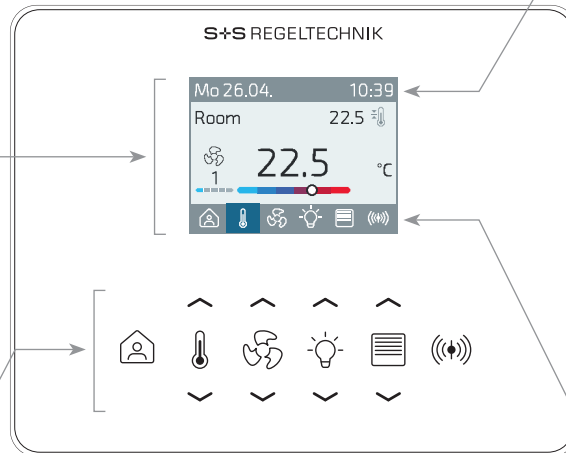

Fig. 011 Icons, using type 1401-LB as an example

#### KEYPAD (TOUCHKEYS)

##### SETPOINT ADJUSTMENT AND MENU ACCESS VIA ARROW KEYS

- UP
- DOWN

**Note:**  
Some keys are assigned additional functions in the configuration menu.

##### BASIC FUNCTIONS MENU ACCESS FOR PRESENCE AND SENSORS

- PRESENCE
- TEMPERATURE
- FAN
- SENSORS

##### ADDITIONAL FUNCTIONS KEY EXTENSION FOR 1 OR 2 ZONES

- LIGHT
- SUN PROTECTION

**Options:**  
1x light / 1x sun protection,  
1x or 2x light,  
1x or 2x sun protection

#### HEADER

Mo 26.04. 10:39

STANDARD DISPLAY  
Weekday, date, time,  
summer/winter time  
(can be set via Modbus).

Mo 26.04. 10:39

STATUS DISPLAY  
ROOM CLIMATE

- WINDOW CONTACT
- DEW POINT
- FROST PROTECTION
- ECO MODE

Mo 26.04. 10:39

MESSAGES

- USB-C
- FAULT / ALARM

#### FOOTER



##### MENU STATUS (Options are type-dependent)

- Active menu selection
- Menu currently not accessed

**Note:**  
Only functions integrated in the unit type are also displayed as an icon in the footer.

#### OVERVIEW OF ICONS

PRESENCE PRESENT	TEMPERATURE	WINDOW CONTACT
PRESENCE ABSENT	HEAT	DEW POINT
SENSORS	COOL	FROST PROTECTION
FAN	OFF	ECO MODE
SUN PROTECTION / BLIND	AUTOMATIC	USB-C
LIGHT	KEY LOCK / LOCKED	FAULT / ALARM

## USER INTERFACE

Layout and operating modes

### [Configuration register](#)

#### Darkmode

[Display\\_Darkmode\\_2024](#)

#### Display Brightness

[Display\\_Brightness\\_2011](#)

#### Language

[Language\\_2009](#)

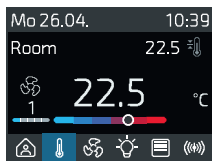

Display Darkmode

## 2.0 User interface, general information

In addition to the bright display view (Fig. 012), you can also activate **darkmode**. The **brightness** can be individually set.

Six **languages** are available:

German, English (default), Spanish, French, Italian, Russian

Default **labels** are already provided in each language (see top left in the menu content, e.g. Room) for specific environments. Regardless of this, each label can be individually changed.

You can use a maximum of 12 characters for this.

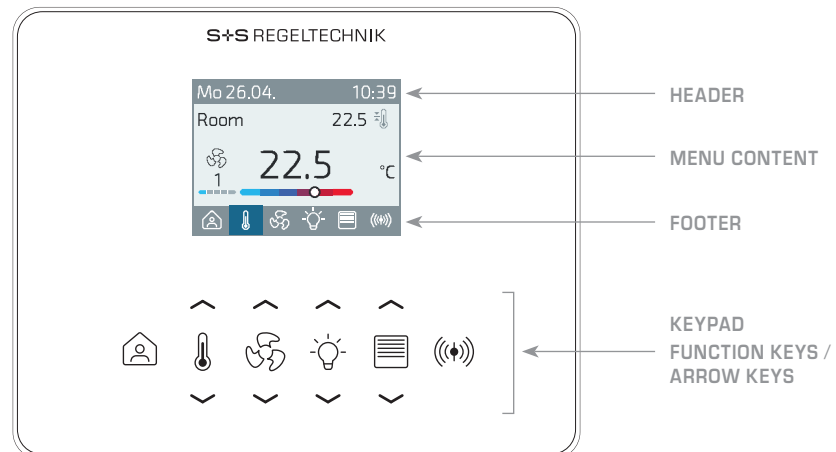

Fig. 012 HMI layout

### [Data register](#)

Lock for individual keys or key pairs:

[Temperature, Fan, Presence RCBMS\\_409\\_bitField](#)

#### Sun protect

[SP\\_AutoMode\\_700\\_bitField](#)

#### Light

[L\\_AutoMode\\_1100\\_bitField](#)

### [Configuration register](#)

#### Time and date

[Time\\_Format\\_2015](#)

[Date\\_Format\\_2016](#)

[Time\\_SetSummerWinter\\_2017](#)

### [Data register](#)

#### Time and date

[Date\\_Time\\_2018-2023](#)

#### Header Icons Modbus

[HeaderIconModbus\\_411\\_bitField](#)

## 2.1 HMI layout (Human Machine Interface)

### Keypad (touch keys)

Operation takes place directly via the keypad.

The menus are accessed via the labelled function keys themselves or via the corresponding **UP** and **DOWN** arrow keys.

The values in the menu can also be adjusted using the arrow keys.

The **BMS** can temporarily **block** individual keys or key pairs for the user on site.

**Note:** The user interface corresponds to the respective **unit type**, i.e., only integrated functions or sensors are available for selection.

### Header on the display (Header)

The **date** and **time** are constantly shown in the header.

In addition to the time and date format, you can also configure an automatic switchover between summer and winter time.

For further relevant information, see chapter 1.6 'Time setting (time/date)'.

The **Header Icons Modbus** parameters can be used to show various icons on the BMS (Fig. 013). If the icons are switched via a configured DI input, you have to observe chapter 7 'Inputs'. The room climate icons trigger specific controller functions (see chapter 9 'Controller').

In normal operation, you can display the following **room climate** icons in parallel:

Window contact – Dew point – Frost protection – ECO mode

In the event of a fault or active access via the USB-C interface, the following **status message** icons are **automatically** displayed (Fig. 014):

USB-C interface connected – fault / alarm

When a status message stops, the display automatically switches back to the configured room climate icons. The appearance and position of the header icons are permanently programmed into the unit and cannot be changed.



Fig. 013 Header - Room climate



Fig. 014 Header - Status messages

## USER INTERFACE

Layout and  
operating modes

### 2.1 HMI layout (continuation)

#### Footer on the display (Footer)

All available functions are shown in the footer (depending on unit type).

The icon of the menu currently open is highlighted in colour in the footer.

The appearance and position of the footer icons are permanently programmed into the unit and cannot be changed.

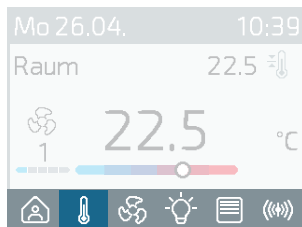

Fig. 015 Footer - Temperature active

### 2.2 Screen saver

The screen saver helps to reduce energy consumption.

In the default settings, the graphical user interface is automatically deactivated if the unit is not operated for 20 seconds. The screen saver appears.

For this, the display switches to black and only the current temperature display moves within the screen area.

Touching **any key** reactivates the graphical user interface (GUI) and the **Home screen** (Setpoint temperature adjustment) appears on the display.

[Configuration register](#)

[Screen saver](#)

[ScreenSaver\\_Timeout\\_2012](#)



Fig. 016 Screen saver

### 2.3 Cleaning mode (key lock for 20 s)

To access the cleaning mode, you must press and hold down the **SENSOR** (⦿) key, immediately followed by the **DOWN** (∨) arrow key for the temperature adjustment. Press both keys together for **3 seconds** (Fig. 017).

Immediately afterwards, all buttons are temporarily locked for **20 seconds**. Meanwhile, the **cleaning countdown** counts down on the display (Fig. 018).

After the countdown has finished, the cleaning mode **ends automatically** and the **Home screen** (Setpoint temperature adjustment) appears on the display.

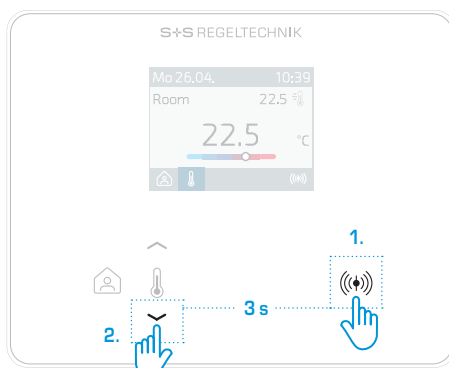

Fig. 017 Accessing the cleaning mode

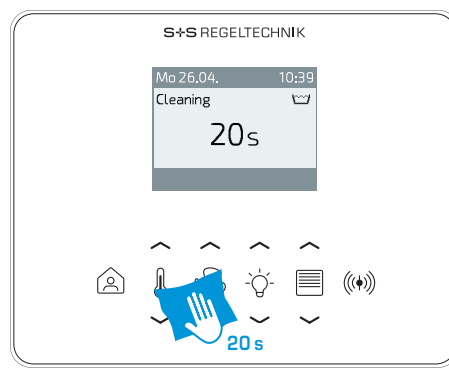

Fig. 018 Cleaning mode - Key lock with countdown



Do not introduce any liquids into the unit! Use exclusively a slightly damp cloth for cleaning. The unit will remain connected to the mains during this time – special care must be taken. No liability is assumed for damage caused by improper cleaning.

### 2.4 Key lock (child safety lock)

To activate or deactivate the key lock, press and hold the **SENSOR** (⦿) key, immediately followed by the **UP** (∧) arrow key for temperature adjustment. Press both keys together for **3 seconds** (Fig. 019).

The active key lock is indicated in the header by the **LOCKED** (🔒) icon (Fig. 020). After deactivation, the Home screen (Setpoint temperature adjustment) appears on the display.

**Note:** The **BMS** can block individual keys or key pairs for the user on site. This is not indicated on the display. Deactivation is only possible via the BMS.

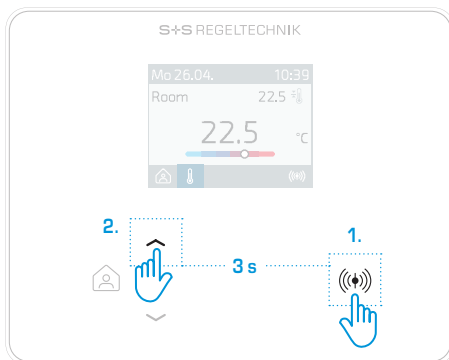

Fig. 019 Activating / deactivating the key lock

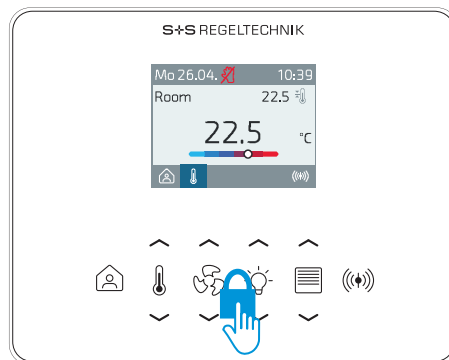

Fig. 020 Icon in header - Key lock active



**TEMPERATURE SETPOINT**

Display and adjustment

[Data register](#)

[Room Climate Controlled By BMS](#)  
 RCBMS\_409\_bitField

**3.0 Temp menu, general information** (Setpoint temperature adjustment)

The setpoint temperature is set using the **UP**  and **DOWN**  arrow keys next to the **TEMPERATURE**  icon (Fig. 021).

The BMS can use the **Room Climate Controlled By BMS** parameter to temporarily block manual adjustment (Manual mode) for the user. This locking is shown on the display.

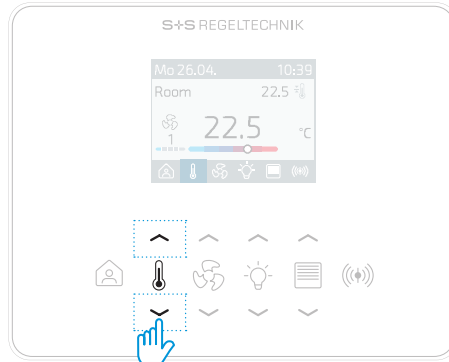

Fig. 021 Setpoint temperature adjustment via arrow keys

**Display**

In the Temp menu, it is possible to show or hide the current temperature, unit, setpoint temperature, operating mode, label and current fan levels (Fig. 022). The display is configured via the Modbus register.

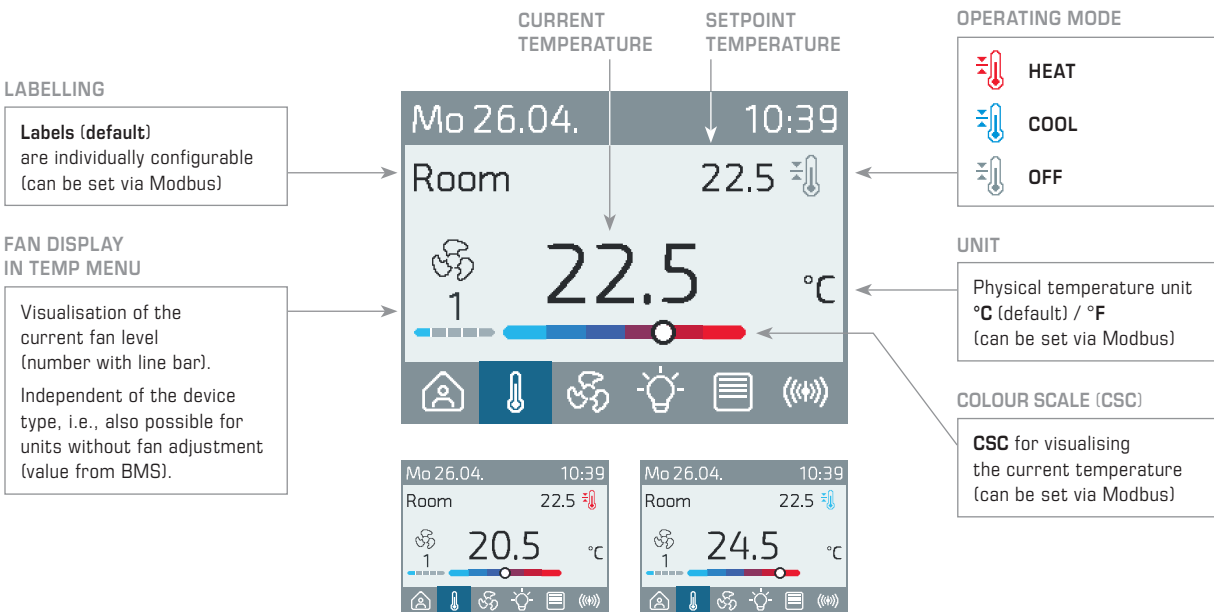

Fig. 022 Temp menu elements

### Configuration register

**Current Temp Mapping**  
CurrentTemp\_Mapping\_3650

**Temp unit**  
Temp\_Unit\_2010

**Display Temp Setpoint**  
Setpoint\_Temp\_Display\_3602

**Display Current Temp**  
CurrentTemp\_Display\_3651

### Data register

**Temp Sensor 1 int. value**  
TempS1Int\_Value\_100

**Temp Sensor 2 ext. value**  
TempS2Ext\_Value\_106

**Temp Sensor 3 bus value**  
TempS3Bus\_Value\_120

### Configuration register

**Temp Setpoint Offset Step Size**  
Setpoint\_Temp\_Offset\_StepSize\_3600

**Display OpMode**  
OpMode\_Display\_3601

**Temp Setpoint After Reboot**  
Setpoint\_Temp\_AfterReboot\_3603

**Temp Setpoint Offset Min-Max After Reboot**  
Setpoint\_Temp\_Offset\_MinMax\_AfterReboot\_3604

**Display Fan In Temp Menu**  
Fan\_DisplayInTempMenu\_3764

### Data register

**Temp Setpoint**  
Setpoint\_Temp\_400

**Temp Setpoint Offset**  
Setpoint\_Temp\_Offset\_401

**Temp Setpoint Absolut**  
Setpoint\_Temp\_Absolut\_402

**Temp Setpoint Offset Min-Max**  
Setpoint\_Temp\_Offset\_MinMax\_403

**OpMode Status**  
OpMode\_Status\_404

## 3.1 Current temperature

A total of three **temperature channels** is available. These can be assigned to the current temperature in the configuration tab via the **Current Temp Mapping** parameter.

The **values** of the individual channels are stored in the data register (read or read/write register).

1. Temperature channel: **Internal sensor** (default)  
Parameter: **Temp Sensor 1 int. value**
2. Temperature channel: **Externer Sensor** (input must be appropriately configured)  
Parameter: **Temp Sensor 2 ext. value**
3. Temperature channel: **Bus value**  
Parameter: **Temp Sensor 3 bus value**

The temperature **unit** can be configured for all channels.  
Default °C can be changed to °F.

The **colour scale (CSC)** is mapped to the current temperature and is used for better visualisation of cold or warm environments. Each sensor has its own CSC, which is factory-set to a value range in °C. The CSC must be adjusted when switching to °F.  
(For configuration, please see chapter 5)

The **label** is mapped to the sensor and can be configured via the **Temp Sensor...Label** parameter for each of the three temperature channels (internal/external/bus).  
(For details, please see chapter 5)

The **display** of the current temperature can be hidden using the **Display Current Temp** parameter or replaced with another sensor (e.g. relative humidity or CO2).

## 3.2 Setpoint temperature

The display of the setpoint temperature can be configured as follows using the **Display Temp Setpoint** parameter:

- **Nothing displayed**
- **Temp Setpoint Absolut** (default)
- **Temp Setpoint Offset**

Alternatively, you can use the **Display Temp Setpoint** parameter to display another sensor instead of the setpoint temperature (e.g. relative humidity or CO2). If set to Alternative and the setpoint temperature is changed using the keys, the display switches briefly to the setpoint temperature and then switches back to the alternative one.

The absolute setpoint temperature (**Temp Setpoint Absolut**) is calculated from the sum of the setpoint and offset. The setpoint (**Temp Setpoint**) is set via the bus or configuration software. The offset (**Temp Setpoint Offset**) can be changed via the keys or bus during operation.



The **Temp Setpoint Offset Min-Max** parameter can be used to specify the limits for the setpoint adjustment via the keys.

The values **Temp Setpoint** and **Temp Setpoint Offset Min-Max** are stored in the volatile memory (VRAM) and are reset to their default after the unit is restarted. The default parameters can be specified via the two **Temp Setpoint After Reboot** and **Temp Setpoint Offset Min-Max After Reboot** parameters.

The setpoint increment is set with the **Temp Setpoint Offset Step Size** parameter.

## 3.3 Operating mode

The following **icons** are displayed to indicate the current operating mode:

 **COOL** (cooling) –  **HEAT** (heating) –  **OFF** (cooling/heating off)

The icons can be hidden using the **Display OpMode** parameter.

## 3.4 Fan display

The display of the current fan level (number with line bar) in the Temp menu can be shown or hidden using the **Display Fan In Temp Menu** parameter.

**Note:** Fan levels are displayed in the Temp menu regardless of whether the unit has or doesn't have fan adjustment. For units without fan adjustment, the fan levels are specified exclusively by the BMS.

The operating principle and configuration of the fan adjustment are explained in the subsequent chapter 4 'Fan menu'.

## FAN CONTROL

Display and adjustment

[Configuration register](#)

[Display Fan In Temp Menu](#)  
[Fan\\_DisplayInTempMenu\\_3764](#)

[Data register](#)

[Room Climate Controlled By BMS](#)  
[RCBBMS\\_409\\_bitField](#)

## 4.0 Fan menu, general information (fan adjustment)

The **Fan menu** is only available for unit types **with** fan adjustment. The user can adjust the fan manually (Manual mode) using the **UP** and **DOWN** arrow keys next to the **FAN** icon (Fig. 023).

The **fan levels** can be displayed in the **Temp menu** by the BMS, regardless of the unit type (see chapter 3.4 'Fan display').

The BMS can use the **Room Climate Controlled By BMS** parameter to temporarily block manual adjustment (Manual mode) for the user. This locking is not shown on the display.

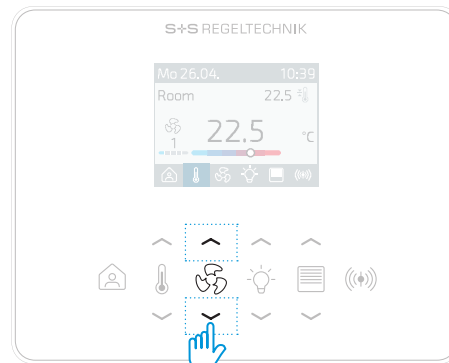

Fig. 023 Fan adjustment via arrow keys

### Display

Fan levels, number of fan steps, operating statuses (Auto/Off) and labels can be displayed in the fan menu (Fig. 024).

The display is configured via the Modbus register.

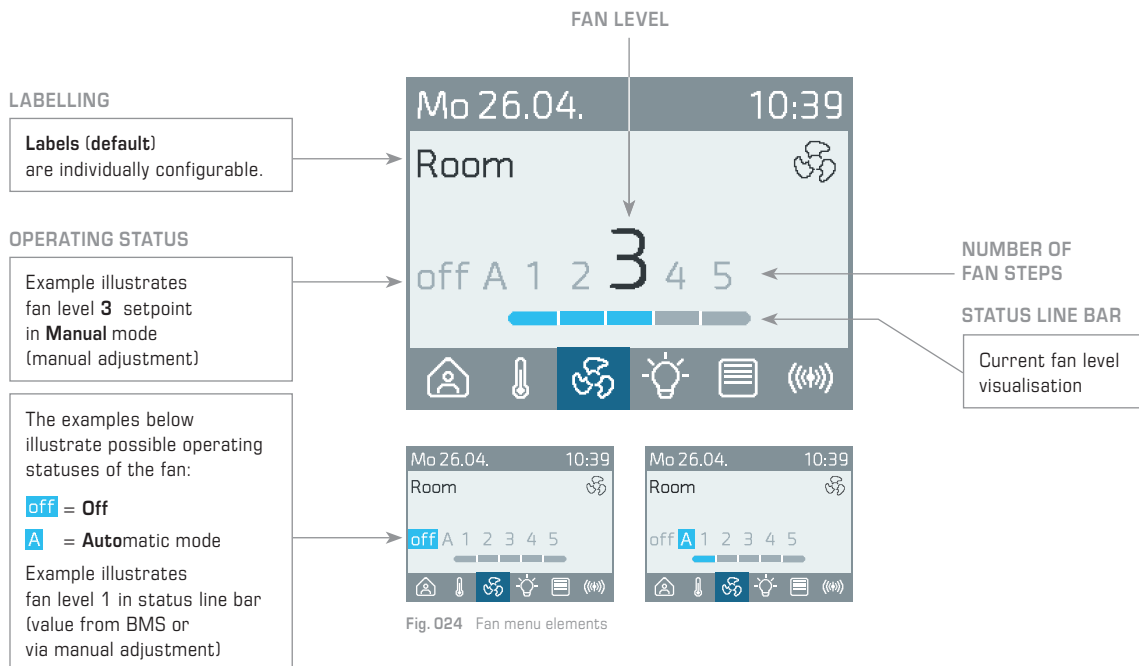

Fig. 024 Fan menu elements



[Configuration register](#)

**Number of Fan Steps**  
 Fan\_NumberOfSteps\_3762

**Enable Fan Auto / Off in Manual mode**  
 Fan\_EnableAutoOff\_3763

**Fan Label**  
 Fan\_Label\_3750-3761

[Data register](#)

**Fan Auto Mode**  
 Fan\_AutoMode\_406

**Fan Level**  
 Setpoint\_Fan\_Level\_407

**Room Climate Controlled By BMS**  
 RCBBMS\_409\_bitField

### 4.1 Number of fan steps

The number of fan speeds (1-5) depends on the type of fan being operated. The corresponding number is entered via the **Number of Fan Steps** parameter to obtain a realistic representation.

### 4.2 Fan operating status (Auto / Off)

The two fan operating states, 'Auto' and 'Off', are enabled for Manual mode by the operator on site via the **Enable Fan Auto / Off** parameter.

**Auto** = fan in Automatic mode (default)

**Off** = fan off

The behavior of the controller is described in Chapter 9 'Controller'.

### 4.3 Fan label

Default labels are provided for the fan in each language (see chapter 'HMI layout'). Irrespective of this, the label can be changed individually via the **Fan Label** parameter. You can use a maximum of 12 characters for this.

### 4.4 Setpoint fan level

The entries for fan control in normal operation are made via the two parameters **Fan Auto Mode** and **Fan Level** (see table).

	<b>Status 1</b> Manual mode	<b>Status 2</b> Automatic mode
<b>Fan Auto Mode</b> Fan_AutoMode_406	'Manual'	'Auto'
<b>Fan Level</b> Setpoint_Fan_Level_407	'Off / 1...5'	Value from controller (see chapter 9 'Controller')

If the touch keys or the BMS are used to set it to **Automatic mode** (State 2), the internal controller sets the Fan Level (Off / 1...5).

The last change has priority in Auto mode (touch keys or BMS). The BMS can use the **Room Climate Controlled By BMS** parameter (bit-coded holding register incl. coil mapping) to temporarily block manual adjustment (manual mode) for the user.

**SENSORS & SENSOR MENU**

Display, configuration and calibration

**5.0 Sensor menu, general information (sensor display)**

To access the **Sensor menu**, you have to press the **SENSOR** ((☎)) key (Fig. 025). The first activated sensor then appears on the display. To switch to the next enabled sensor, press the sensor button again.

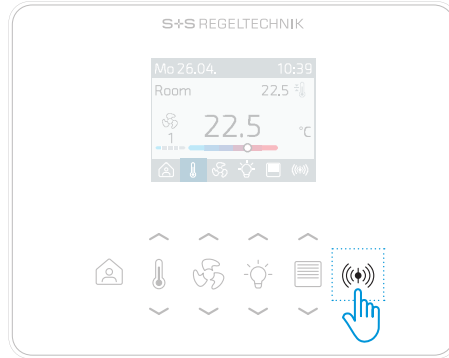

Fig. 025 Accessing the Sensor menu

**Sensors and display**

All units are equipped with a **digital temperature and humidity sensor** as standard. **Internal sensors** for CO2 and VOC are optionally available (depending on unit type).

**External sensors** can be written to and displayed on the unit via the bus.

It is also possible to connect a **passive sensor** at the input directly to the unit.

The current sensor values are shown on the **display** as a numerical value with a unit and, if necessary, also as a colour scale (Fig. 026). The display is configured via the Modbus register.

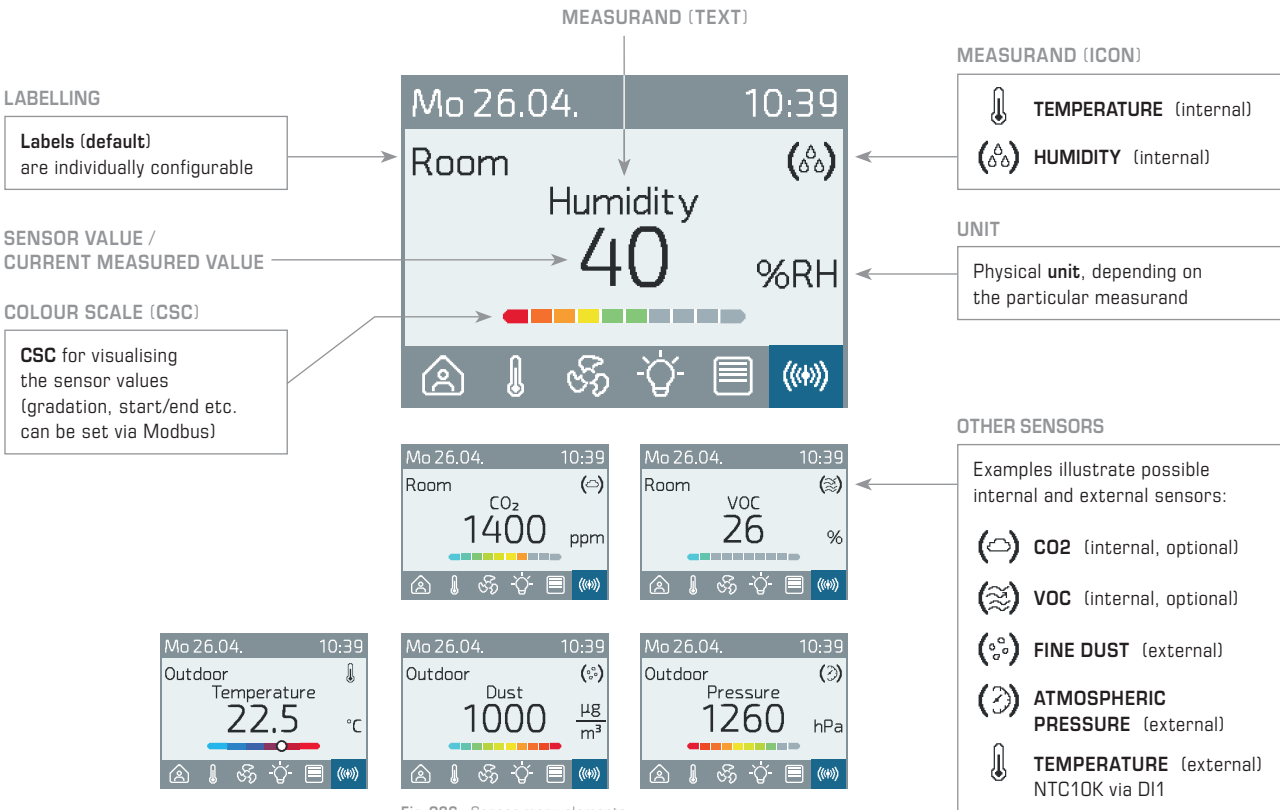

Fig. 026 Sensor menu elements

[Configuration register](#)

**Temp Unit**  
Temp\_Unit\_2010

**Pressure 2 Bus Unit**  
PressureS2Bus\_Unit\_3516

**VOC Sensor 2 Bus Unit**  
VOCS2Bus\_Unit\_3316

### 5.1 Sensor menu configuration

All internal and external sensors (except for the internal temperature sensor) are enabled for display by default (**Sensor menu display** = enabled).

As soon as the unit receives a measured value, it is displayed in the corresponding sensor menu. The following table shows all the sensors that can be displayed in the sensor menu, including the register addresses.

#### Physical unit

The temperature unit can be overridden for all temperature channels via the **Temp Unit** parameter (default °C/°F).

If the **atmospheric pressure** (value from BMS) should be indicated on the display, the unit can be selected via the **Pressure Sensor 2 Bus Unit** parameter (default hPa/Pa/mbar/inWC)

For the display of an external **VOC**-sensor (value from BMS) the unit can be selected via the **VOC Sensor 2 Bus Unit** (default % / ppb).

#### Colour scale (CSC)

For quick visualisation, the measured value is displayed under the numerical value as a colour scale (default). This can be hidden via the **Show Colour Scale** parameter of the respective sensor channel or configured individually via the **Colour Scale Start** and **Colour Scale End** parameters (see table).

#### Labelling

All sensors come with default **sensor labels** in each language.

Irrespective of this, each label can be changed individually using the **Sensor Label** parameter. You can use a maximum of 12 characters for this.

Sensor register table (excerpt) with holding addresses	Display in sensor menu				Colour scale (CSC)		Labelling	
	Value Value...	Offset Offset...	Averaging time Averaging Time...	Sensor menu display EnableIn SensorMenu...	CSC display EnableColour Scale...	CSC start / end ColourScale_Start/End...	Labelling Label...	
<b>Internal sensors</b> (type-dependent)								
Temp Sensor 1	TempS1Int_...	100	2312	2313	2317	2318	2314 / 2315	2300-2311
RH Sensor 1	HumS1Int_...	101	2412	2413	2417	2418	2414 / 2415	2400-2411
CO2 Sensor 1	CO2S1Int_...	102	2512	2513	2517	2518	2514 / 2515	2500-2511
VOC Sensor 1	VOCS1Int_...	103 (ppb) 104 (%)	-	2613	2617	2618	2614 / 2615	2600-2611
<b>External passive sensor</b> (Input DI1)								
Temp Sensor 2	TempS2Ext_...	106	2912	2913	2917	2918	2914 / 2915	2900-2911
<b>External sensors</b> (Values from BMS)								
Temp Sensor 3	TempS3Bus_...	120	-	-	3017	3018	3014 / 3015	3000-3011
RH Sensor 2	HumS2Bus_...	121	-	-	3117	3118	3114 / 3115	3100-3111
CO2 Sensor 2	CO2S2Bus_...	122	-	-	3217	3218	3214 / 3215	3200-3211
VOC Sensor 2	VOCS2Bus_...	123	-	-	3317	3318	3314 / 3315	3300-3311
PM Sensor 2	PMS2Bus_...	124	-	-	3417	3418	3414 / 3415	3400-3411
Pressure Sensor 2	PressureS2Bus_...	125	-	-	3517	3518	3514 / 3515	3500-3511

[Data register](#)

**CO2 Sensor 1 int. auto calibration**  
CO2S1Int\_AutoCalibr\_302

### 5.2 Calibrating the internal CO2 and VOC sensors

Units with an integrated CO2 and/or VOC sensor perform automatic calibration. Ventilating the rooms regularly with fresh air increases the measuring accuracy of the sensors. The automatic calibration of the CO2 sensor is activated by default. The automatic calibration of the VOC sensor cannot be deactivated.

All that is required for **automatic calibration** (CO2/VOC) is a regular supply of fresh air. The unit recognises this status and automatically performs self-calibration.

Proceed as follows to perform self-calibration:

Open all windows fully or set the air conditioning system to use outdoor air once weekly for 15 - 20 minutes. If possible, everyone should leave the room (CO2) or else the release of volatile organic substances/mixed gases (VOC) should be prevented.

[Data register](#)

**CO2 Sensor 1 int. reset auto zero**  
CO2S1Int\_ResetAutozero\_300

**Manual calibration** (CO2) can be carried out independently of automatic calibration.

Proceed as follows to perform manual calibration:

First, open all windows fully or set the air conditioning system to use outdoor air for 15 - 20 minutes. If possible, everyone should leave the room during this time.

Start the **Autozero** process via the bus or the RYMConfig software.

Keep the windows open or the air conditioning system set to use outdoor air.

After **10 minutes**, the manual calibration process (CO2) is ready.

The bus value for Autozero jumps back to **OFF** when activated.

## PRESENCE / ABSENCE

Display and configuration

[Configuration register](#)

[Presence Function](#)  
[Presence\\_Function\\_3800](#)

[Data register](#)

[Presence Status](#)  
[Presence\\_Status\\_405](#)

[Room Climate Controlled By BMS](#)  
[RCBBMS\\_409\\_bitField](#)



**Devices with 24V supply:**

Input 1 and input 2 may only be switched to GND (potential-free)!

Applying voltage to the two inputs will destroy the unit!



**Devices with 230 V supply:**

Input 2 is a 230 V input (observe connection diagram!).

The power supply and input must be connected to the same phase.

## 6.0 Presence menu, general information (changing presence)

The **PRESENCE**  key is pressed to open the Presence menu (Fig. 027) and carry out a presence change. In the 'absent' status, unit operation is defined via **Presence Function**.

The BMS can temporarily disable the PRESENCE key via the **Room Climate Controlled By BMS** parameter.

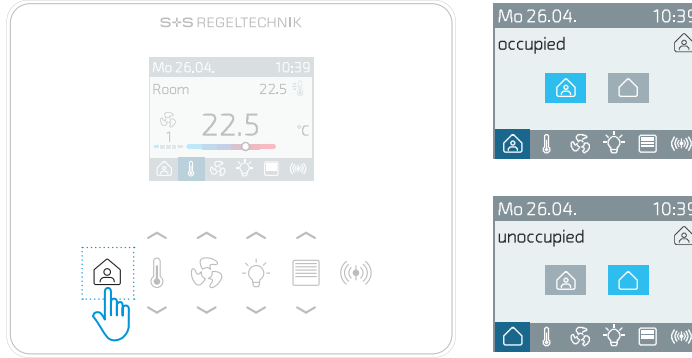





Fig. 027 Accessing the Presence menu

### Display and labelling

Active presence status is indicated by the **OCCUPIED**  or **UNOCCUPIED**  icons.

The labels in the respective language are permanently stored and cannot be changed by the user.

Language		
English (default)	occupied	unoccupied
German	anwesend	abwesend
French	présent	absent
Spanish	presente	ausente
Italian	presente	assente
Russian	занят	свободно

### Presence change

The room occupancy is stored in the **Presence Status** register and the icon 'occupied (present)' or 'unoccupied (absent)' is controlled by this. The **Presence Status** register can be influenced in three ways:

- Via the **PRESENCE key** on the unit
- Via the **Presence Modbus** register
- Via the digital inputs **DI1 / DI2**

## PRESENCE

Logic

### 6.1 Presence status

You can see how the Presence Change parameters influence each other in the following simplified illustration (Fig. 028):

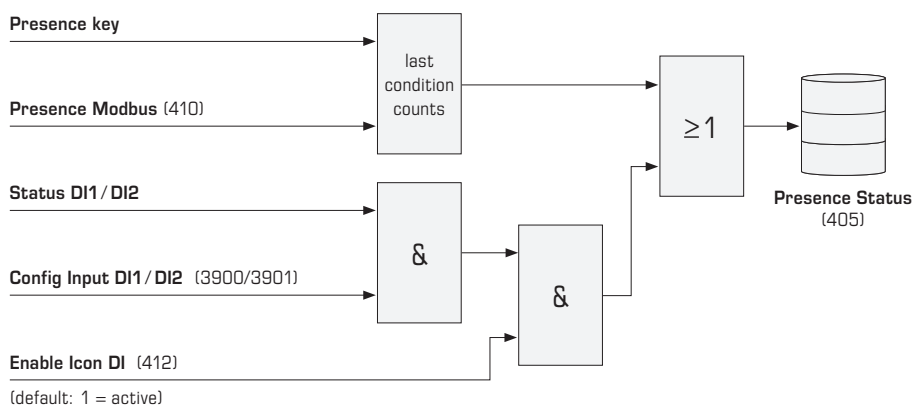

Fig. 028 Presence change

#### [Configuration register](#)

**Input 1 Config**  
 Input1\_Config\_3900

**Input 2 Config**  
 Input2\_Config\_3901

**Presence Function**  
 Presence\_Function\_3800

**Presence Enable DI Reboot**  
 Enable\_PresenceDI\_Reboot\_3801

#### [Data register](#)

**D1 Input Status**  
 D1Input\_Status\_126

**D2 Input Status**  
 D2Input\_Status\_127

**Presence Modbus**  
 Presence\_Mod\_410

**Presence Status**  
 Presence\_Status\_405

**Enable Presence DI**  
 Enable\_PresenceDI\_412

The **Presence Modbus** parameter and the **presence key** on the unit are equivalent. The last state set determines the **Presence Status**.

If a digital input (DI1 or DI2) is used as a **presence contact**, it has priority and determines the **presence status**.

As long as the presence detector on the DI is signalling presence, it is not possible to switch to absence via **Presence Modbus** or the **presence key**.

The two digital inputs DI1 and DI2 can be configured as **presence contacts** using the **Input 1 Config**. and **Input 2 Config**. parameters.

To change the **presence status** via the digital inputs, you must set the **Enable Presence DI** to 'enabled'.

#### Key enable when absent

Operation of the unit while the **Presence Status** parameter is set to 'absent' can be configured as follows using the **Presence Function** parameter:

1. Changing the presence status to 'present' via the Presence menu (default).  
 It is possible to navigate through all menus, but setpoint adjustment is not possible.
2. Changing the presence status to 'present' by pressing any key.  
 It is possible to navigate through all menus and adjust setpoints.
3. No status change possible, presence status remains 'present'.  
 It is possible to navigate through all menus and adjust setpoints.

## DIGITAL INPUT DI1 & DI2

### [Configuration register](#)

[Input 1 Config](#)  
Input1\_Config\_3900

[Input 2 Config](#)  
Input2\_Config\_3901

### [Data register](#)

[D1 Input Status](#)  
D1Input\_Status\_126

[D2 Input Status](#)  
D2Input\_Status\_127

[HeaderIconStatus\\_408](#)  
HeaderIconStatus\_...

[Header Icons Modbus](#)  
HeaderIconModbus\_411\_bitField

[Enable Icons DI](#)  
Enable\_IconDI\_413



### Devices with 24V supply:

Input 1 and input 2  
may only be switched to  
GND (potential-free)!

Applying voltage  
to the two inputs will  
destroy the unit!



### Devices with 230 V supply:

Input 2 is a 230 V input  
(observe connection diagram!).

The power supply and  
input must be connected  
to the same phase.

## 7.0 Inputs, general information

The digital inputs **DI1** and **DI2** serve to detect a switching operation via a potential-free contact.

The type of digital inputs can be configured via the parameters **Input 1 Config** (DI1) and **Input 2 Config**. (DI2).





## 7.1 Inputs as presence contact



(see chapter 6.0 'Presence')

## 7.2 Inputs as contact for Header Icons

The icons in the header can be switched via the BMS (refer to chapter 2.1 'HMI layout') or via a configured DI input.

The room climate icons trigger specific controller functions (see chapter 9 'Controller').

In normal operation, you can display the following **room climate** icons in parallel (Fig. 029):  
Window contact  – Dew point  – Frost protection  – ECO mode 

In the event of a fault or active access via the USB-C interface, the following **status message** icons are **automatically** displayed (Fig. 030):  
USB-C interface connected  – Fault / Alarm 

When a status message stops, the display automatically switches back to the configured room climate icons. The appearance and position of the header icons are permanently programmed into the unit and cannot be changed.



Fig. 029 Header - Room climate



Fig. 030 Header - Status messages

The configured icons can be shown or hidden using the **Header Icons Status** parameter. The register can be influenced in two ways:

- Via the **Header Icons Modbus** register
- Via the digital inputs **DI1** / **DI2**

## HEADER ICONS

Logic

### 7.3 Header Icons Status

You can see how the Header Icons parameters influence each other in the following simplified illustration (Fig. 031):

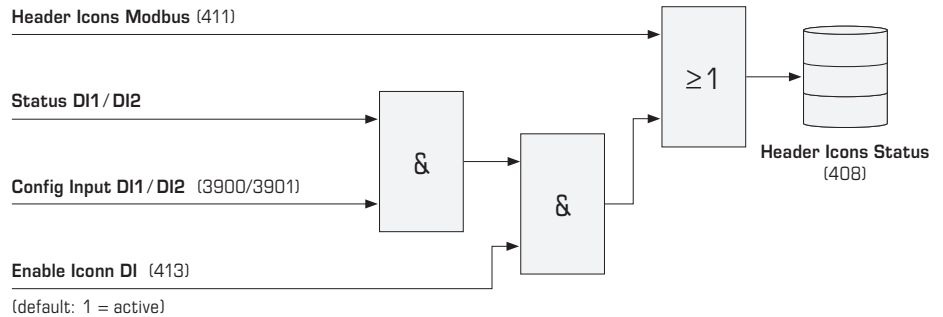

Fig. 031 Frost protection input / window / dew point / ECO

Icon	Input 1 Config Input1_Config_3900  Input 2 Config Input2_Config_3901	D1 Input Status D1Input_Status_126  D2 Input Status D2Input_Status_127	HeaderIconStatus_408_bitField depending on HeaderIconsModbus (411)  Enable Icons DI (413) 1 = active → Icon shown
	13 = Frost protection <b>NO</b> contact	0 = open	depends on HeaderIconsModbus (411, Bit 0)
		1 = closed	1 = active → Frost protection icon shown
	14 = Frost protection <b>NC</b> contact	0 = open	1 = active → Frost protection icon shown
		1 = closed	depends on HeaderIconsModbus (411, Bit 0)
	3 = Window contact <b>NO</b> contact	0 = open	depends on HeaderIconsModbus (411, Bit 1)
		1 = closed	1 = active → Window contact icon shown
	4 = Window contact <b>NC</b> contact	0 = open	1 = active → Window contact icon shown
		1 = closed	depends on HeaderIconsModbus (411, Bit 1)
	5 = Dew point monitors <b>NO</b> contact	0 = open	depends on HeaderIconsModbus (411, Bit 2)
		1 = closed	1 = active → Dew point icon shown
	6 = Dew point monitors <b>NC</b> contact	0 = open	1 = active → Dew point icon shown
		1 = closed	depends on HeaderIconsModbus (411, Bit 2)
	15 = ECO <b>NO</b> contact	0 = open	depends on HeaderIconsModbus (411, Bit 3)
		1 = closed	1 = active → ECO Mode icon shown
	16 = ECO <b>NC</b> contact	0 = open	1 = active → ECO Mode icon shown
		1 = closed	depends on HeaderIconsModbus (411, Bit 3)
	11 = Alarm <b>NO</b> contact	0 = open	depends on HeaderIconsModbus (411, Bit 4)
		1 = closed	1 = active → Alarm/Fault icon shown
	12 = Alarm <b>NC</b> contact	0 = open	1 = active → Alarm/Fault icon shown
		1 = closed	depends on HeaderIconsModbus (411, Bit 4)

## TOUCH KEY EXTENSION

Configuration and ready-to-order variants for additional key pairs for light and sun protection (type-dependent)

### 8.0 Touch key extension, general information

In addition to the basic models (temperature/fan) there are also unit variants available with additional key pairs for **controlling the light and sun protection** (Fig. 032-037).

The unit type must be selected according to the desired light or sun protection circuits. It is not possible to make subsequent changes or additions to the **touch key assignment**.

The numbering of the light or sun protection circuits in the **Modbus register** is fixed and depends on the **code number** of the touch key extension (see table).

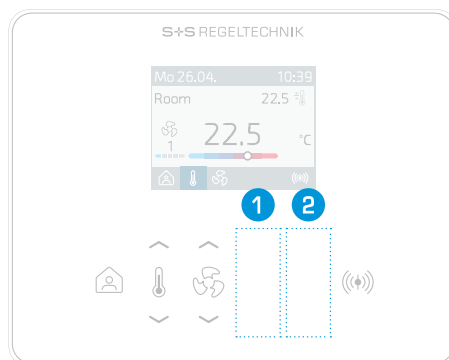

Fig. 032 Example Type 1401 (basic model)

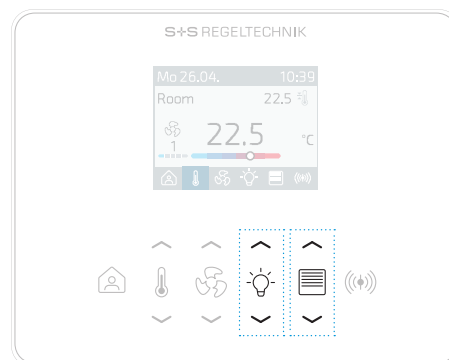

Fig. 033 Example Type 1401-LB

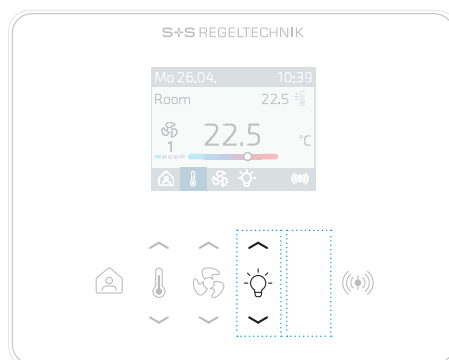

Fig. 034 Example Type 1401-L

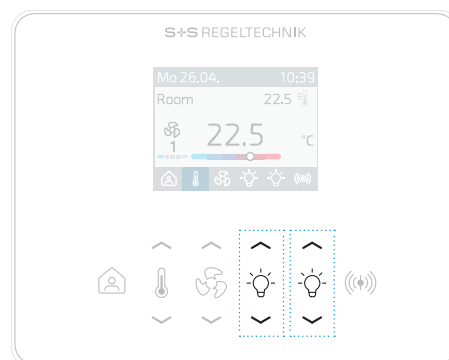

Fig. 035 Example Type 1401-LL

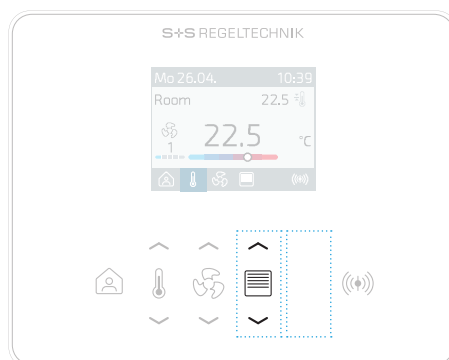

Fig. 036 Example Type 1401-B

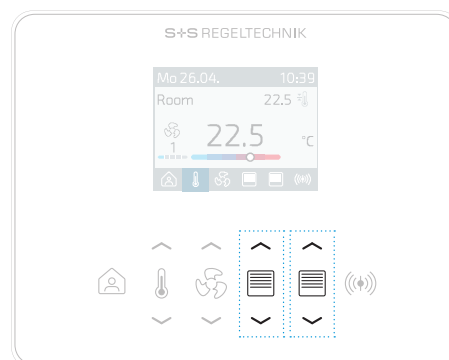
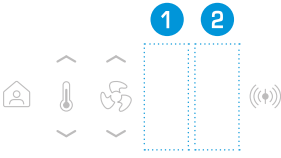

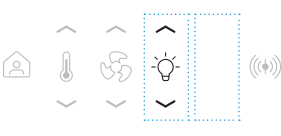
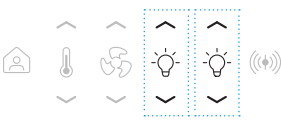



Fig. 037 Example Type 1401-BB



Assignment variants for additional key pairs (Printing on front face of unit)	Key extension		Ready-to-order variants for additional key pairs (Type labelling)
	1 Related linked <a href="#">data register</a>	2 Related linked <a href="#">data register</a>	
	(not assigned)	(not assigned)	<b>Basic models</b> without key extension Type 13xx (Temp.) Type 14xx (Temp.+Fan)
	<b>Light 1</b> L_AutoMode_1100_bitField (bit0) L_LightStatus_1102_bitField (bit0) L1_KeyStatus_1120 L1_Dimm_Value_1121	<b>Sun protect 2</b> SP_AutoMode_700_bitField (bit1) SP2_KeyStatus_730 SP2_Position_Value_731 SP2_Angle_Value_732	<b>1x Light / 1x Sun protection (Blind)</b> Key extension 1+2 Type 13xx-LB Type 14xx-LB
	<b>Light 1</b> L_AutoMode_1100_bitField (bit0) L_LightStatus_1102_bitField (bit0) L1_KeyStatus_1120 L1_Dimm_Value_1121	(not assigned)	<b>1x Light</b> Key extension 1 Type 13xx-L Type 14xx-L
	<b>Light 1</b> L_AutoMode_1100_bitField (bit0) L_LightStatus_1102_bitField (bit0) L1_KeyStatus_1120 L1_Dimm_Value_1121	<b>Light 2</b> L_AutoMode_1100_bitField (bit1) L_LightStatus_1102_bitField (bit1) L2_KeyStatus_1130 L2_Dimm_Value_1131	<b>2x Light</b> Key extension 1+2 Type 13xx-LL Type 14xx-LL
	<b>Sun protect 1</b> SP_AutoMode_700_bitField (bit0) SP1_KeyStatus_720 SP1_Position_Value_721 SP1_Angle_Value_722	(not assigned)	<b>1x Sun protection (Blind)</b> Key extension 1 Type 13xx-B Type 14xx-B
	<b>Sun protect 1</b> SP_AutoMode_700_bitField (bit0) SP1_KeyStatus_720 SP1_Position_Value_721 SP1_Angle_Value_722	<b>Sun protection 2</b> SP_AutoMode_700_bitField (bit1) SP2_KeyStatus_730 SP2_Position_Value_731 SP2_Angle_Value_732	<b>2x Sun protection (Blind)</b> Key extension 1+2 Type 13xx-BB Type 14xx-BB

**Note:**

Even if in the **1x Light / 1x Sun protection (LB)** variant, only one blind is controlled, the Modbus registers for **Sun protect 2** are valid. The numbering or labelling of the register is based on the **code number** of the touch key extension, i.e., **Light 1 / Sun protect 2**.

## SUN PROTECTION (BLIND) CONTROL

Display and icons

### Configuration register

Sun protect display  
SP\_Display\_4201

### Data register

Sun protect auto mode  
SP\_AutoMode\_700\_bitField

## 8.1 Sun Protect menu (sun protection adjustment)

The **Sun Protect menu** is only available for unit types **with** sun protection adjustment. The user can adjust the sun protection manually (Manual mode) using the **UP** and **DOWN** arrow keys next to the **SUN PROTECTION** icon (Fig. 038).

The BMS can use the **Sun protect auto mode** parameter to temporarily block manual adjustment (Manual mode) for the user. When locking is active, the adjustment is carried out exclusively by the BMS. This locking is shown on the display as **Automatic mode** .

The Sun Protect menu can be permanently disabled via the **Sun protect display** parameter. The operator can continue to control the sun protection by visual orientation using the corresponding arrow keys. The display remains unchanged in the process (e.g. in the Temp menu).

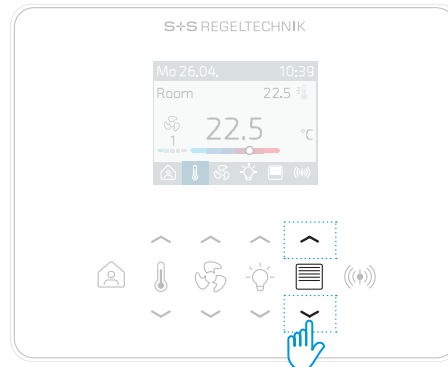

Fig. 038 Sun protection adjustment via arrow keys

### Display

In the Sun Protect menu, it is possible to display the position (Up/Down) and the slat angle (turned left - horizontal - turned right), operating statuses (Auto) and labels (Fig. 039). The display is configured via the Modbus register.

**LABELLING**

**Labels (default)** are individually configurable (can be set via Modbus)

**Note:** Adjustments are made **using the arrow keys** (touch keys) in the keypad.

Manual adjustment (manual mode) blocked by BMS.  
**A** = **Automatic mode**

The examples below show sun protection adjustment in **two zones (BB) = 1/2**

POSITION UP/DOWN    TURNING ANGLE

**POSITION UP/DOWN**

The status line bar visualises the **sun protection position** between **0%** (fully open) and **100%** (fully closed).

**Sun Protect Position value** (can be set via Modbus)

Min. position:	0 %
Max. position:	100 %
Step size:	0.5 %

**Sun Protect Angle Value** (can be set via Modbus)

Max. left rotation:	-80°
Max. right rotation:	80°
Step size:	10°

Fig. 039 Sun Protect menu elements

**Sun Protect Angle Value** (can be set via Modbus)

Max. left rotation:	-80°
Max. right rotation:	80°
Step size:	10°

**SLAT ANGLE**

## SUN PROTECTION (BLIND) CONTROL

Configuration and adjustment

### [Configuration register](#)

#### Sun Protect Label

SP1\_Label\_4250-4261  
SP2\_Label\_4300-4311

#### Sun Protect Type

SP1\_Type\_4264  
SP2\_Type\_4314

#### Sun Protect OpMode

SP1\_OpMode\_4263  
SP2\_OpMode\_4313

### [Data register](#)

#### Sun Protect Key Status

SP1\_KeyStatus\_720  
SP2\_KeyStatus\_730

#### Sun Protect Position Value

SP1\_Position\_Value\_721  
SP2\_Position\_Value\_731

#### Sun Protect Angle Value

SP1\_Angle\_Value\_722  
SP2\_Angle\_Value\_732

### [Configuration register](#)

#### Sun Protect Position Step Size

SP1\_PositionStepSize\_4265  
SP2\_PositionStepSize\_4315

#### Sun Protect Position Min

SP1\_PositionMin\_4267  
SP2\_PositionMin\_4317

#### Sun Protect Position Max

SP1\_PositionMax\_4268  
SP2\_PositionMax\_4318

### [Configuration register](#)

#### Sun Protect Angle Step Size

SP1\_AngleStepSize\_4266  
SP2\_AngleStepSize\_4316

#### Sun Protect Angle Min

SP1\_AngleMin\_4269  
SP2\_AngleMin\_4319

#### Sun Protect Angle Max

SP1\_AngleMax\_4270  
SP2\_AngleMax\_4320

### Labelling

Default labels are predefined in each language for sun protection.

Irrespective of this, each label can be changed individually using the **Sun Protect Label** parameter. You can use a maximum of 12 characters for this.

### Sun protection types

The following variants can be selected via the **Sun Protect Type** parameter:

- **Sun Protect Position** (up/down)
- **Sun Protect Slat Angle** (slat rotation)
- **Sun Protect Position + Slat Angle** (default)

The position of the sun protection can be written using the **Sun Protect Position Value** parameter, and for the slat angle of the slats using the **Sun Protect Angle Value** parameter.

Writing is performed either by the BMS or by the user in 'Default' operating mode (see description for sun protection adjustment in 'Default' operating mode).

### Operating mode and key status





The following variants can be configured via the **Sun Protect OpMode** parameter:

- **'Short-long key press'** for fast bus line (default)  
In the data register **Sun Protect Key Status**, a short (< 1 s) or long (> 1 s) key press is recorded. After reading, the BMS writes back the value **'not pressed'**.  
The BMS writes the position and angle back to the data register **Sun Protect Position Value** and **Sun Protect Angle Value**. The GUI is adjusted.
- **'Hold key press'** for fast bus line (default)  
The key press is registered in the data register **Sun Protect Key Status**, until the user releases the key. After the key is released, the unit resets the value back to **'not pressed'**.  
The BMS writes the position and angle back to the data register **Sun Protect Position Value** and **Sun Protect Angle Value**. The GUI is adjusted.
- **'Setpoint mode'**  
If the user presses one of the two keys, the position and angle are written directly to the registers **Sun Protect Position Value** and **Sun Protect Angle Value**. The GUI is adjusted.  
The BMS retrieves the values as a default.  
For the relationship between pressing the key and adjusting the position and angle, please refer to the description for sun protection adjustment in the 'Setpoint mode' operating mode provided below.





### Sun protection adjustment in 'Setpoint mode' operating mode (Manual mode)

The user makes the adjustment using the arrow keys (touch keys) as follows:

#### Position (up/down)

- Short key press **UP**  (< 1 s) reduces the **Sun Protect Position Value** by the set **Sun Protect Position Step Size** (default: 0.5 %)
- Short key press **DOWN**  (< 1 s) increases the **Sun Protect Position Value** by the set **Sun Protect Position Step Size** (default: 0.5 %)
- Long key press **UP**  (> 1 s) reduces the value automatically depending on the set step size, until one of the two arrow keys is pressed again or **Sun Protect Position Min** is reached (default: 0 %, complete light incidence).
- Long key press **DOWN**  (> 1 s) increases the value automatically depending on the set step size, until one of the two arrow keys is pressed again or **Sun Protect Position Max** is reached (default: 100 %, no light incidence).

#### Slat angle (slat rotation)

- Short key press **UP**  (< 1 s) reduces the **Sun Protect Angle Value** by the set **Sun Protect Angle Step Size** (default: 10°)
- Short key press **DOWN**  (< 1 s) increases the **Sun Protect Angle Value** by the set **Sun Protect Angle Step Size** (default: 10°)
- Long key press **UP**  (> 1 s) reduces the value automatically depending on the set step size, until one of the two arrow keys is pressed again or **Sun Protect Angle Min** is reached (default: 0°).
- Long key press **DOWN**  (> 1 s) increases the value automatically depending on the set step size, until one of the two arrow keys is pressed again or **Sun Protect Angle Max** is reached (default: 80°).

## LIGHTS CONTROL

Display and icons

### Configuration register

Light display  
L\_Display\_5301

### Data register

Light auto mode  
L\_AutoMode\_1100\_bitField

## 8.2 Light menu (light adjustment)

The **Light menu** is only available for unit types **with** light adjustment.

The user can adjust the light manually (Manual mode) using the **UP** and **DOWN** arrow keys next to the **Light** icon (Fig. 040).

The BMS can use the **Light auto mode** parameter to temporarily block manual adjustment (Manual mode) for the user. This locking is shown on the display as **Automatic mode** **A**.

The Light menu can be permanently disabled via the **Light display** parameter. The operator can continue to control the room lighting by visual orientation using the corresponding arrow keys.

The display remains unchanged in the process (e.g. in the Temp menu).

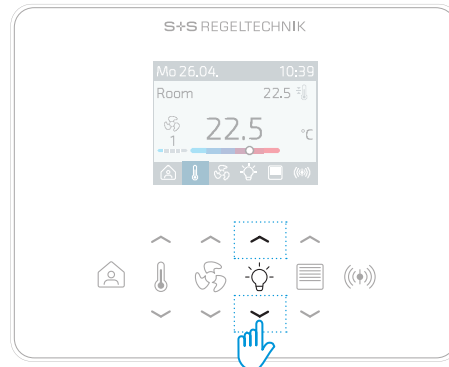

Fig. 040 Light adjustment via arrow keys

### Display

In the Light menu, it is possible to display all statuses (Off/On, Dimming value 0...100 %), operating statuses (Auto) and labels (Fig. 041).

The display is configured via the Modbus register.

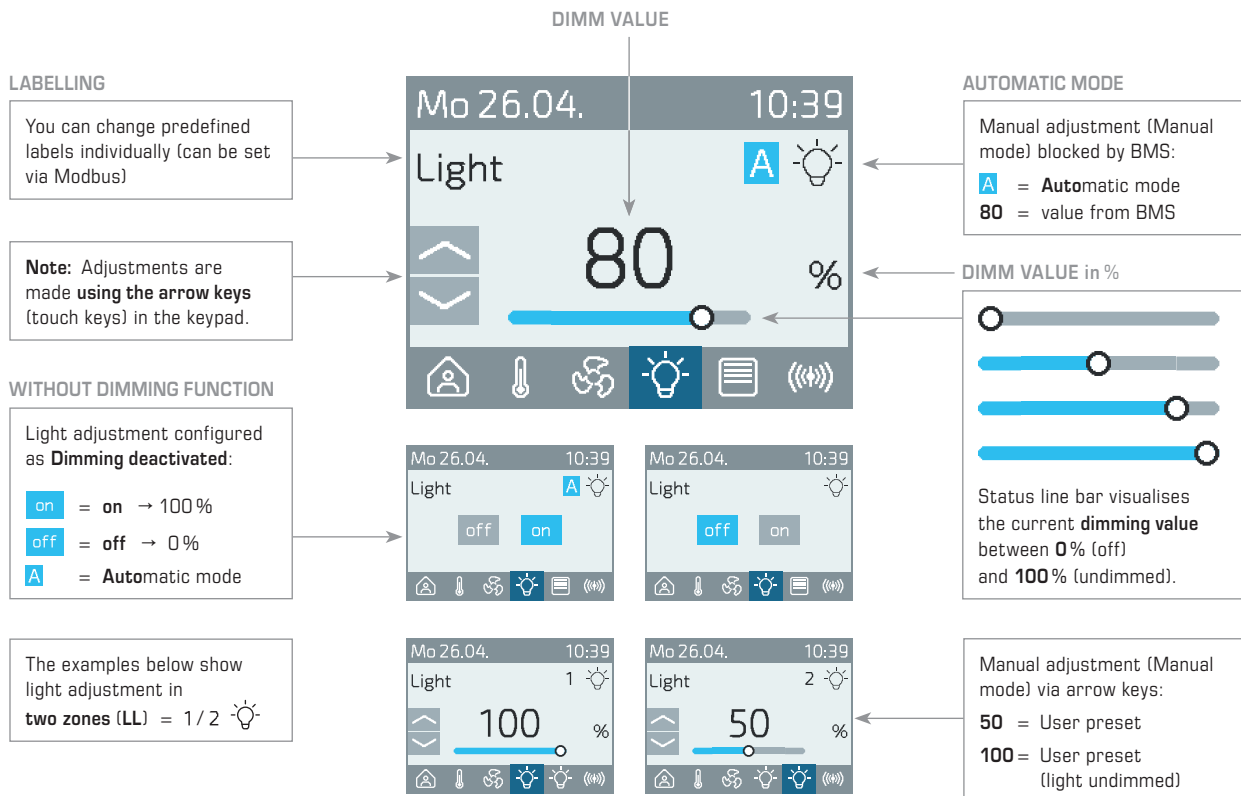

Fig. 041 Elements in the Light menu

## LIGHTS CONTROL

Configuration and adjustment

### [Configuration register](#)

#### Light Label

L1\_Label\_5350-5361  
L2\_Label\_5400-5411

#### Light Dimmable

L1\_Dimmable\_5363  
L2\_Dimmable\_5413

#### Light OpMode

L1\_OpMode\_5364  
L2\_OpMode\_5414

### [Data register](#)

#### Light Key Status

L1\_KeyStatus\_1120  
L2\_KeyStatus\_1130

#### Light Dimm Value

L1\_Dimm\_Value\_1121  
L2\_Dimm\_Value\_1131

#### Light Status

L\_LightStatus\_1102\_bitField

## Labelling

Default labels are predefined in each language for the light. Irrespective of this, each label can be changed individually using the **Light Label** parameter. You can use a maximum of 12 characters for this.

## Light types and statuses

The following light types can be selected via the **Light Dimmable** parameter:

- **Light dimming deactivated** (off: 0 % / On: 100 %)
- **Light dimming activated** (Dimming value: 0...100 %) (default)

The dimming value is written via the **Light Dimm Value** parameter. Writing is performed either by the BMS or by the user in 'Setpoint mode' operating mode (see description for light adjustment in 'Setpoint mode' operating mode).

The **Light Status** parameter is mapped to the coil register and linked with the holding parameter **Light Dimm Value**:

- **Dimm Value = 0 %** (by the user or BMS) → bit in **Light Status** to 0
- **Dimm Value > 0 %** (by the user or BMS) → bit in **Light Status** to 1

The **Light Status** parameter (coil mapping) lets you switch on or off all lights with a bit change (0/1). The **Dimm Value** is thereby set to 0 % or 100 %.

Note: The unit does not keep the previous value.

### Example 1

**Light 1** has the dimming value of 50 % (dimmed). This gives the following parameter entries as a result: **Light 1 Dimm Value** = 50, **Light Status** bit 0 = 1 (coil mapping)

The BMS now switches to **Light Status** (bit 0) or from 1 to 0 in the corresponding coil register. The **Light Dimm Value** parameter follows automatically and has the final value of 0.

### Example 2

**Light 1** has the dimming value of 0 % (light Off). This gives the following parameter entries as a result: **Light 1 Dimm Value** = 0, **Light Status** bit 0 = 0 (coil mapping)

The BMS now switches to **Light Status** (bit 0) or from 0 to 1 in the corresponding coil register. The **Light Dimm Value** parameter follows automatically and has the final value of 100.

## Operating mode and key status

The following variants can be configured via the **Light OpMode** parameter:

- **Short-long key** (default)  
In the data register **Light Key Status**, a short (< 1 s) or long (> 1 s) key press is recorded. After reading, the BMS writes back the value 'not pressed'.  
The BMS writes the dimming value to the **Light Dimm Value** data register. The GUI is adjusted.
- **Hold key press**  
The key press is registered in the data register **Light Key Status** until the user releases the key. After the key is released, the unit resets the value back to 'not pressed'.  
The BMS writes the dimming value to the **Light Dimm Value** data register. The GUI is adjusted.
- **Setpoint mode**  
If the user presses one of the two keys, the Dimm value is written directly to the data register **Light Dimm Value**. The GUI is adjusted. The BMS retrieves the values as a default.  
For the relationship between pressing the key and adjusting the Dimm value, please refer to the description for sun protection adjustment in 'Setpoint mode' operating mode provided below.

## Light adjustment in 'Setpoint mode' operating mode (Manual mode)

The user makes the adjustment using the arrow keys (touch keys) as follows:

### Light dimming activated (Dimm value: 0...100 %)

- Short key press **UP** ⬆ (< 1 s) increases the **Light Dimm Value** by the set **Light Dimm Step Size** (default: 10 %)
- Short key press **DOWN** ⬇ (< 1 s) reduces the **Light Dimm Value** by the set **Light Dimm Step Size** (default: 10 %)
- Long key press **UP** ⬆ (> 1 s) sets the value automatically to 100 %.
- Short key press **DOWN** ⬇ (> 1 s) sets the value automatically to 0 %.

### Light dimming deactivated (off: 0 % / on: 100 %)

Pressing the **UP** ⬆ or **DOWN** ⬇ key (irrespective of the key press duration) sets the value to 0 % (off) or 100 % (on) in the data register **Light Dimm Value**.

### [Configuration register](#)

#### Light Dimm Step Size

L1\_DimmStepSize\_5368  
L2\_DimmStepSize\_5418

## CONTROLLER

General information and configuration

### [Configuration register](#)

[Controller OpMode After Reboot](#)  
[ContrOpMode\\_AfterReboot\\_8053](#)

### [Data register](#)

[Controller OpMode](#)  
[ContrOpMode\\_Setpoint\\_1607](#)  
[Change-Over Status](#)  
[ChangeOver\\_Status\\_1600](#)

### [Configuration register](#)

[2. Control Loop Type](#)  
[2.ContrLoopType\\_8044](#)

### [Data register](#)

[Controller OpMode](#)  
[ContrOpMode\\_Setpoint\\_1607](#)  
[Change-Over Status](#)  
[ChangeOver\\_Status\\_1600](#)

## 9.0 Controller general information

The RYMASKON® 1000 Controllers are based on the RYMASKON® 1000 Interface.

Whereas the interface has no outputs and only makes the data points available on the bus, the controllers have integrated controls and outputs for controlling valves, fan coils, fans, etc. The available controller types with different outputs can be found in the type table and connection diagrams (see 'Device data').

### Heating or cooling mode

The specification for heating or cooling mode can be set in two ways:

#### 1. Specification via BMS:

##### Controller OpMode

- 0 = Off
- 1 = Cooling Auto (heating disabled →  $Y_H = 0\%$ )
- 2 = Heating Auto (cooling disabled →  $Y_C = 0\%$ )
- 3 = Cooling and Heating Auto (default)

The default value after device restart is configured via the parameter **Controller OpMode After Reboot**.

#### 2. Change-Over:

##### Change-Over Status

- 0 = Change-Over disabled (default)
- 1 = Cooling mode (heating control loop locked)
- 2 = Heating mode (cooling control loop locked)

An enabled Change-Over (Cooling/Heating) has priority over **Controller OpMode**. The options for changing the **Change-Over Status** are described in Chapter 9.2 'Change-over'.

##### Important:

In Change-Over mode, the heating and cooling outputs are controlled in parallel, i.e. both outputs receive the same heating or cooling power. The exception is when using the second control loop (refer to Chapter 9.4.2 'Second control loop (temperature controller)').

### Control loops

The RYMASKON® 1000 Controller has up to three independent control loops:

#### 1. Control loop (temperature control)

- Main control loop for temperature control
- Specification for heating or cooling mode via the **Controller OpMode** or **Change-Over Status** parameter
- Control of the heating, cooling output or 6-way valve

#### 2. Control loop (temperature control)

- Second control loop for temperature control
- Only works in Change-Over mode (together with the 1st control loop)
- Enabling via parameter **2. Control Loop Type**
- Cooling output control

#### 3. Control loop (fan / RCV control)

- Only for type RYMASKON 143xC / 144xC / 145xC / 146xC (fancoil controller)
- Follows heating/cooling (default)
- Can be configured to control humidity, CO<sub>2</sub> and VOC (RCV control, dehumidification only, CO<sub>2</sub> reduction, VOC reduction)
- 'Fan' output control

### Configuration register

**Dead Band Comfort**  
DeadBand\_Comfort\_8006

**Dead Band ECO**  
DeadBand\_ECO\_8007

**Occupied Override ECO**  
Occupied\_OvrrECO\_8002

**Change-Over\_DI-Temp**  
ChangeOver\_DITemp\_8054

### Data register

**Header Icon Status**  
HeaderIconStatus\_ECO\_408\_bit3

**Controller OpMode**  
ContrOpMode\_Setpoint\_1607

**Change-Over Status**  
ChangeOver\_Status\_1600

### Comfort mode

Comfort mode is equivalent to the 'present' presence status. The controller is in default mode. In comfort mode, the dead band between heating and cooling is set to the configured **Dead Band Comfort** (default: 1°C).

The dead band is only enabled if the **Controller OpMode** parameter is set to 'Cooling and Heating Auto' and Change-Over is disabled (**Change-Over Status**).

### ECO mode

An enabled ECO mode can be retrieved via the **Header Icons Status** parameter. The options for enabling/disabling ECO mode are described in chapter 7 'Digital inputs & header icons'.

In ECO mode, the dead band between heating and cooling is automatically set to the configured **Dead Band ECO** (default: 4°C).

The dead band is only enabled if the **Controller OpMode** parameter is set to 'Cooling and Heating Auto' and Change-Over is disabled (**Change-Over Status**).

If the presence function is used in parallel, the **Occupied Override ECO** parameter can be used to configure whether the 'present' presence status overrides an enabled ECO mode (overtime function).

#### Note:

If the ECO mode and the Change-Over are to be switched via the DI inputs, the Change-Over has priority. If the **Change-Over\_DI-Temp** parameter is used to assign the Change-Over to a DI input, the same input cannot be configured for ECO mode at the same time.

### Configuration register

**Setpoint Temp Shift Unoccupied**  
Setpoint\_TempShift\_Unocc\_8000

**Setpoint Temp Offset  
Presence Change**  
Setpoint\_Temp\_Offs\_PresChange\_8001

**Change-Over\_DI-Temp**  
ChangeOver\_DITemp\_8054

### Data register

**Presence Status**  
Presence\_Status\_405

**Temp Setpoint**  
Setpoint\_Temp\_400

**Temp Setpoint Offset**  
Setpoint\_Temp\_Offset\_401

**Controller OpMode**  
ContrOpMode\_Setpoint\_1607

**Change-Over Status**  
ChangeOver\_Status\_1600

### Presence

The presence status can be called up via the **Presence Status** parameter. The options for changing the presence status are described in Chapter 6 'Presence'. In the 'absent' state, the controller performs the following steps:

1. If the controller is configured for cooling or heating mode, the temperature setpoint (**Temp Setpoint**) is lowered (in heating operation) or raised (in cooling mode) by the **Setpoint Temp Shift Unoccupied** parameter.
2. If the controller is configured for cooling and heating mode, the dead band is changed to twice the value of the **Setpoint Temp Shift Unoccupied** parameter.
3. The setpoint offset set by the user (**Temp Setpoint Offset**) is reset to 0°. The **Setpoint Temp Offset Presence Change** parameter can be used to set whether the original setpoint offset should be restored when 'present'.

#### Note:

If the presence and the Change-Over are to be switched via the DI inputs, the Change-Over has priority. If the **Change-Over\_DI-Temp** parameter is used to assign the Change-Over to a DI input, the same input cannot be configured as a presence contact at the same time.

### Standby (Controller Off)

Standby (Off) is configured via the **Controller OpMode** parameter. The keys, display and building protection are remain enabled. The controllers maintain the current temperature within the building protection (refer to Chapter 9.1 'Temperature Setpoint (Main control loop)').

#### [Configuration register](#)

##### [Anti-Jam \(Valve Protection\)](#) Anti-Jam\_8052

##### [Underfloor Heat Protection Sensor](#) UnderfloorHeatProtection\_Sensor\_8050

##### [Underfloor Heat Protection Limit](#) UnderfloorHeatProtection\_Limit\_8051

##### [RODO Min. Runtime Heat/Cool](#) RODO\_MinRuntime\_HeatCool\_8029

##### [Delay Switch Heat/Cool](#) DelaySwitch\_Heat/Cool\_8030

#### Valve Protection (Anti-Jam)

The anti-jam function helps ensure that the valves do not jam if they are not used for a long time. The unit activates the valves briefly for this purpose:

- **Heating and cooling output** is activated for 5 minutes (valve open).
- **6-way valve** is first set to 10 V for 5 minutes and then to 0 V.

The inactivity time is specified via the **Anti-Jam** parameter (default: 3 days). The value '0' disables this function.

#### Underfloor Heat Protection Limit

If the limit is exceeded, the unit reduces the heating power to 0%.

The value is specified via the parameter **Underfloor Heat Protection Limit** (default: 34 °C).

Limit value monitoring is enabled automatically when a temperature sensor is selected via the **Underfloor Heat Protection Sensor** parameter.

#### Minimum runtime, RO / DO output for heating/cooling (heat pump function, only with 2-point control)

The digital RO / DO heating or cooling output remains in the On state for the configured minimum runtime after switching on, regardless of the heating or cooling power ( $Y_H$  /  $Y_C$ ) of the controller.

The time is specified via the **RODO Min. Runtime Heat/Cool** parameter. The value '0' (default) disables this function.

If a change-over between heating and cooling occurs during active monitoring of the minimum running time, the outputs are changed over directly and the runtime monitoring is restarted.

#### Delay changing over between heating/cooling (heat pump function)

The change between the two heating and cooling control sequences takes place with a time delay. The heating or cooling output is only enabled after the configured delay time has elapsed.

The time is specified via the **Delay Switch Heat/Cool** parameter. The value '0' (default) disables this function.



[Configuration register](#)

**Dead Band Comfort**  
DeadBand\_Comfort\_8006

**Dead Band ECO**  
DeadBand\_ECO\_8007

**Frost Protection**  
Frost\_Protection\_8041

**Heat Protection**  
Heat\_Protection\_8042

[Data register](#)

**Temp Setpoint Absolut**  
Setpoint\_Temp\_Absolut\_402

**Controller Setpoint Temp**  
Controller\_Setpoint\_Temp\_1616

**Controller OpMode**  
ContrOpMode\_Setpoint\_1607

**Change-Over Status**  
ChangeOver\_Status\_1600

**Header Icons Status (Window Contact)**  
HeaderIconStatus\_WindowContact\_408\_bit1

## 9.1 Temperature Setpoint (main control loop)

The parametrisation, adjustment and display of the temperature setpoint is described in Chapter 3.2 'Setpoint temperature'.  
The controller has additional functions.

### Controller Setpoint Temp ( $T_{\text{Setpoint Contr}}$ )

The reference variable for temperature control (setpoint) is stored in the **Controller Setpoint Temp** ( $T_{\text{Setpoint Contr}}$ ). The setpoint is composed as follows.

In 'Cooling and Heating Auto' operating mode:

$$T_{\text{Setpoint Contr}} = \text{Temp Setpoint Absolut} - \frac{\text{Dead Band}}{2} \quad (\text{Heating mode})$$

$$T_{\text{Setpoint Contr}} = \text{Temp Setpoint Absolut} + \frac{\text{Dead Band}}{2} \quad (\text{Cooling mode})$$

If building protection is enabled:

$$T_{\text{Setpoint Contr}} = \text{Frost Protection} \quad (\text{Heating mode})$$

$$T_{\text{Setpoint Contr}} = \text{Heat Protection} \quad (\text{Cooling mode})$$

Otherwise:

$$T_{\text{Setpoint Contr}} = \text{Temp Setpoint Absolut} \quad (\text{Heating or cooling mode})$$

### Dead Band

The dead band is only enabled in 'Cooling and Heating Auto' operating mode.  
Within the dead band, the manipulated variable ( $Y_H / Y_C$ ) remains at the configured minimum value (default: 0%).

### Building protection (Frost Protection and Heat Protection)

Building protection is enabled if the Change-Over function is disabled and one of the following two conditions is met:

- **Controller OpMode** is on 'Off'.
- **Window Contact** is on 'open'.  
For configuration, see chapter 7 'Digital inputs and header icons'.

The building protection sets the **Controller Setpoint Temp** to the configured parameters **Frost Protection** and **Heat Protection**. In this case, the dead band is disabled.

The controllers remain switched off until the temperatures of the protective functions are reached. If the current temperature reaches the temperature of the frost or heat protection, the controller is switched on again and the corresponding output is activated.

When frost protection is enabled, the icon  appears in the display header (refer to Chapter 'Icons').

[Configuration register](#)

[Change-Over\\_DI-Temp](#)  
ChangeOver\_DITemp\_8054

[Change-Over Temp Cooling](#)  
ChangeOver\_TempCooling\_8055

[Change-Over Temp Heating](#)  
ChangeOver\_TempHeating\_8056

[Data register](#)

[Controller OpMode Setpoint](#)  
ContrOpMode\_Setpoint\_1607

[Change-Over Modbus](#)  
ChangeOver\_Modbus\_1602

[Change-Over Status](#)  
ChangeOver\_Status\_1600

## 9.2 Change-Over

As an alternative to Modbus specification, the heating or cooling mode can be controlled via the Change-Over. In Change-Over mode, the heating and cooling outputs are controlled in parallel, i.e. both outputs receive the same heating or cooling power.

The exception is when using the second control loop (refer to Chapter 9.4.2 'Second control loop (temperature controller)').

The Change-Over is used in heating and cooling systems in which the heat exchanger (FBH, cooling ceiling, radiator, etc.) is operated in a 2-pipe system. A control valve is connected upstream of the heat exchanger to adjust the flow rate of the medium. The control valve does not differentiate between heating and cooling operation.

The change-over between heating and cooling medium takes place at an upstream mixer (4-pipe system for simultaneous alternating heating and cooling) or is provided by the cooling/heating unit depending on the season (cooling only in summer, heating only in winter).

Any change-over of the medium must be communicated to the RYMASKON controller via the Change-Over signal (Modbus or DI). The following parameters are available for configuration/specification:

- **Change-Over DI\_Temp** (default: Change-Over disabled)
- **Change-Over Modbus** (higher priority)

The unit alternatively recognises the Change-Over automatically based on the supply temperature of the medium. To do this, the external temperature sensor can be connected to the flow pipe, or else the flow temperature can be transmitted to the unit via Modbus (temperature bus). In this case, the **Change-Over\_DI-Temp** parameter must be set to external or bus temperature sensor. The temperature limits are defined via the **Change-Over Temp Cooling** and **Change-Over Temp Heating** parameters.

The following example (Fig. 901) shows an air conditioning system with seasonal change-over. The control valve on the heat exchanger is connected to the heating output AO1 (terminal 7) of the RYMASKON 132xC unit type. Only the heating controller is enabled in winter (heating mode). When you switch to cooling mode in summer, the Change-Over signal of the chiller changes over and only the cooling controller is enabled.

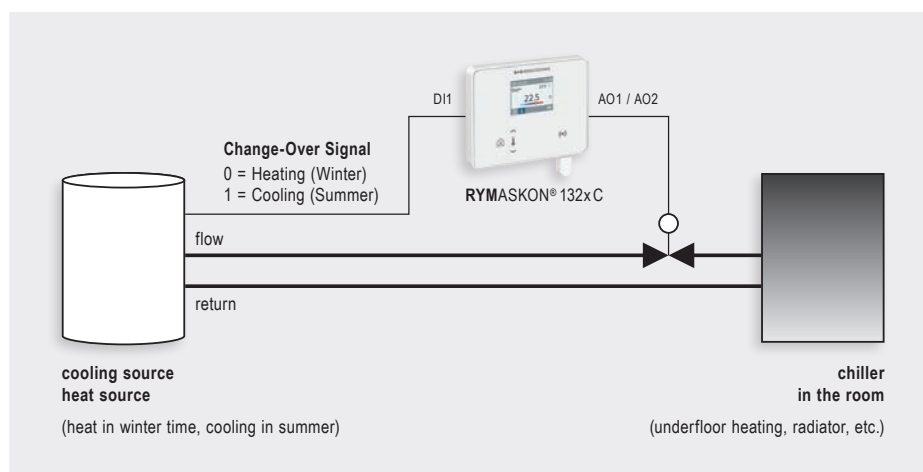

Fig. 901 Change-Over | 2-wire system

An **enabled** Change-Over (Cooling/Heating) has priority over **Controller OpMode Setpoint**. The status can be retrieved via the **Change-Over Status** parameter.

**Note:** If Change-Over is configured to a switching contact or external temperature sensor at the input via the **Change-Over\_DI-Temp** parameter, the corresponding input cannot assume any other function. Value changes via the bus are reset.

[Configuration register](#)

**Change-Over\_DI-Temp**  
ChangeOver\_DI\_Temp\_8054

**Input 1 Config**  
Input1\_Config\_3900

**Input 2 Config**  
Input2\_Config\_3901

[Data register](#)

**Header Icons Status**  
HeaderIconStatus\_DewPoint\_408\_bit2  
HeaderIconStatus\_WindowContact\_408\_bit1=1

**Controller Setpoint Temp**  
Controller\_Setpoint\_Temp\_1616

[Configuration register](#)

**Controller Typ Heating**  
ContrTyp\_Heating\_8003

**Controller Typ Cooling**  
ContrTyp\_Cooling\_8004

### 9.3 Dew point and window contact

An enabled dew point or window contact can be retrieved via the **Header Icons Status** parameter. The options for changing the status are described in Chapter 7 'Digital inputs and header icons'.

If the dew point or window contact and the Change-Over are to be switched via the DI inputs, the change-over has priority. If the **Change-Over\_DI-Temp** parameter is used to assign the Change-Over to a DI input, the same input cannot be configured as dew point or window contact at the same time.

#### Dew point

An enabled dew point (condensation present) locks the cooling controller ( $Y_C = 0\%$ ). Condensation is detected via the **Header Icon Status** parameter. An external dew point monitor must be used, the unit does not detect dew points.

#### Window contact

The building protection is enabled when a window contact (open window) is triggered (refer to Chapter 9.1 'Temperature Setpoint (main control loop)'). Open windows are detected via the **Header Icon Status** parameter.

### 9.4 Temperature control

RYMASKON Controllers have a PI and 2-point controller for heating and cooling. The parameters of the control sequences for heating and cooling can be separately set.

In addition to the main control loop (1st control loop), a second control loop (2nd control loop) can be enabled, for example to control an adjacent room using the RYMASKON Controller.

#### 9.4.1 Main control loop (temperature controller)

##### PI controller (main control loop)

The controller types for heating and cooling the main control loop can be configured via the **Controller Typ Heating** and **Controller Typ Cooling** parameters. The following parameters have an influence on the PI controller of the main control loop.

Parameter	Holding address	Range	
<b>Controller Typ Heating = PI controller</b>			
<b>Proportional Band X<sub>p</sub> Heating</b>	8013	0.1...27.0 °C/°F	(default: 2 °C/4 °F)
<b>Reset Time T<sub>i</sub> Heating</b>	8014	0...1200 minutes	(default: 20 minutes)
<b>Manipulated Variable Min. Heating</b>	8015	0...100 %	(default: 0 %)
<b>Manipulated Variable Max. Heating</b>	8016	0...100 %	(default: 100 %)
<b>Controller Typ Cooling = PI controller</b>			
<b>Proportional Band X<sub>p</sub> Cooling</b>	8009	0.1...27.0 °C/°F	(default: 2 °C/4 °F)
<b>Reset Time T<sub>i</sub> Cooling</b>	8010	0...1200 minutes	(default: 20 minutes)
<b>Manipulated Variable Min. Cooling</b>	8011	0...100 %	(default: 0 %)
<b>Manipulated Variable Max. Cooling</b>	8012	0...100 %	(default: 100 %)
<b>Heating and Cooling</b>			
<b>Y Min Deviation PI Temp Control Loop</b>	8018	0...10 %	(default: 0.2 %)
<b>Manipulated Variable Min. Behavior</b>	8019	0 / 1	(default: 0) 0 = At least the set minimum value is present at the output as heating/cooling power (default) 1 = Heating/cooling power is only applied to the output from the set min. value.
<b>PWM Cycle Time (for outputs DO/RO)</b>	8005	5...60 minutes	(default: 30 minutes)

Tab. 001 Configuring the PI controller for main control loop (temperature controller)

**PI controller (main control loop)**  
 continued

With the PI controller, the temporal behaviour is determined via the two parameters **Proportional Band  $X_P$**  and **Reset Time  $T_N$** .

Due to the proportional (P), the manipulated variable reacts immediately to any temperature difference. The integral part (I) acts with time. The control difference ( $dT_{\text{Setpoint Contr}}$ ) is calculated as follows:

$$dT_{\text{Contr}} = T_{\text{Setpoint Contr}} - T_{\text{Current}}$$

The value for  $T_{\text{Setpoint Contr}}$  and  $T_{\text{Current}}$  depends on the operating mode and configuration (refer to Chapter 9.1 'Temperature Setpoint (Main control loop)' and 3.1 'Current temperature').

The resulting manipulated variable ( $Y_H / Y_C$ ) is applied as a PWM signal to an RO/DO output or as a continuous signal to an AO output.

The calculation of the manipulated variable is illustrated in simplified form in the following diagram (Fig. 902). The diagram for the control variable can be derived from it as a function of the setpoint/current temperature. (Fig. 903)

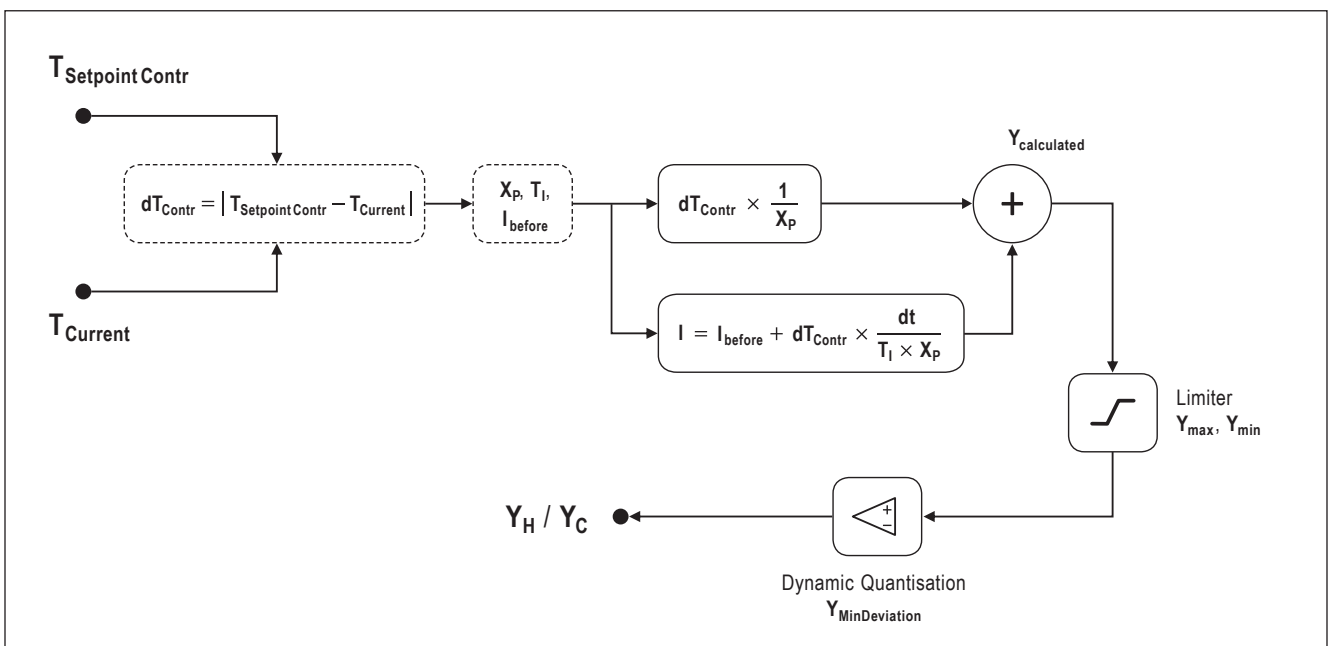

Fig. 902 PI controller (main control loop) | Calculation of manipulated variables ( $Y_H/Y_C$ )

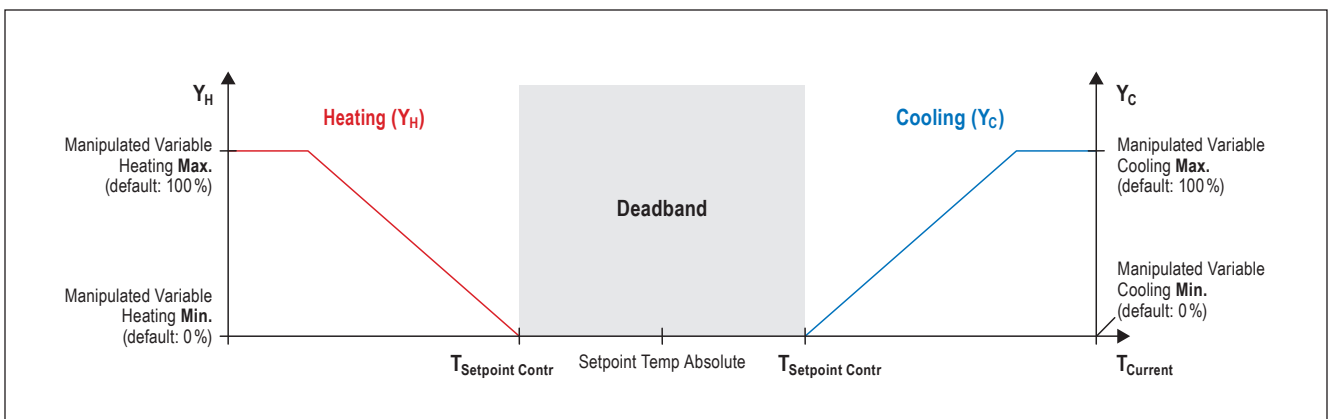

Fig. 903 PI controller (main control loop) | Manipulated variables ( $Y_H/Y_C$ ) as a function of the setpoint/current temperature

**PI controller (main control loop)**  
 continued

The Limiter is configured via the parameter **Manipulated Variable Max...** and **Manipulated Variable Min...** (refer to **Fig. 903** and **Tab. 001**).

The **Manipulated Variable Min. Behavior** parameter can also be used to configure whether at least the set min. value is applied to the output (**Fig. 904**) or whether the calculated manipulated variable  $Y_{\text{calculated}}$  is only applied to the output from the set min. value (**Fig. 905**).

The following diagrams show examples with 'Manipulated Variable Min. Heating = 20%'.

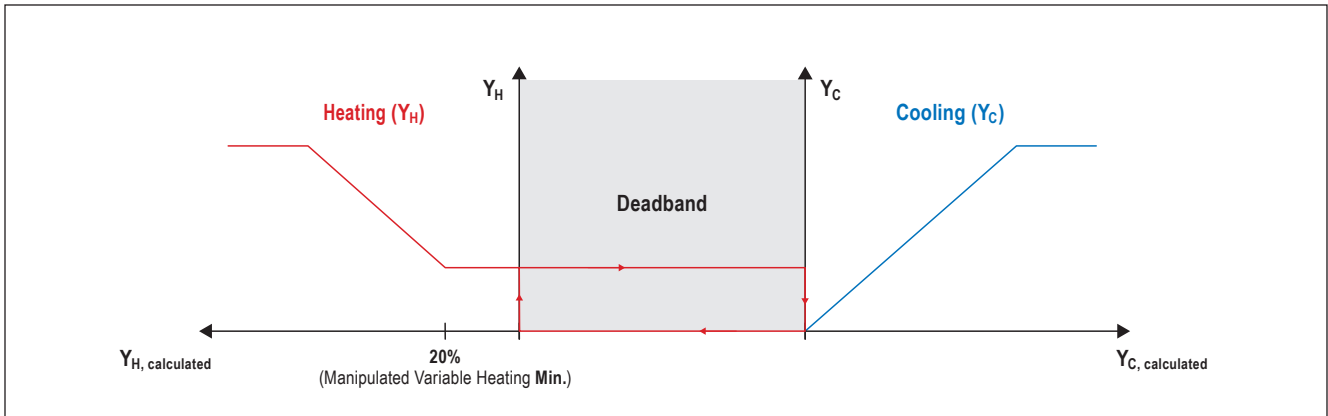

Fig. 904 PI controller (main control loop) | Manipulated Variable Min. Behavior = 0

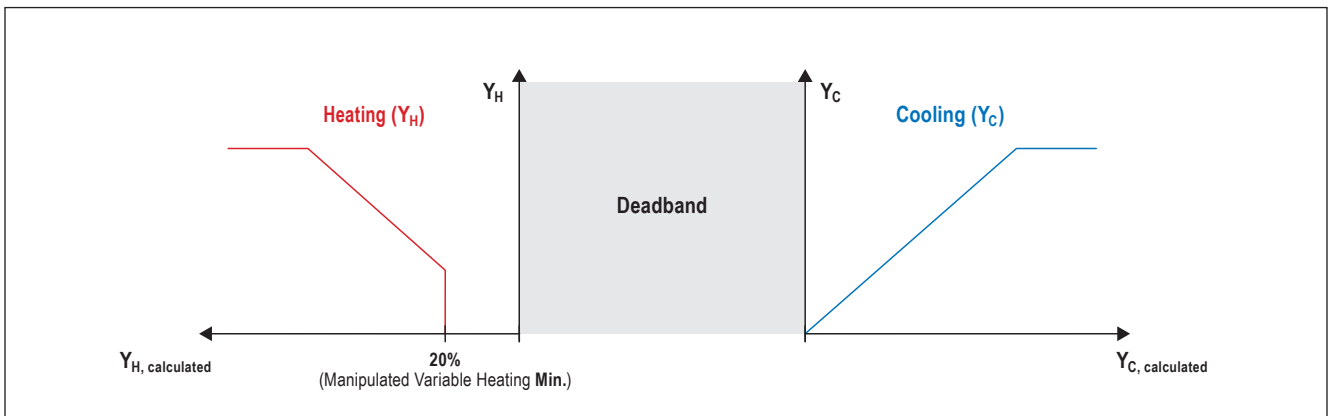

Fig. 905 PI controller (main control loop) | Manipulated Variable Min. Behavior = 1

The **Y Min Deviation PI Temp Contol Loop** parameter can be used to quantise the output linearly (stepped output change).

The **Y Min Deviation PI Temp Contol Loop** parameter sets the step amount (refer to **Fig. 902** and **Tab. 001**).

For RYMASKON Controllers with RO/DO outputs for heating/cooling, the continuous output signal of the PI controller is output as a PWM value. The period duration is set via the **PWM Cycle Time** parameter.

Example: **PWM Cycle Time** = 40 minutes, manipulated variable  $Y_H = 25\%$   
 → 'Heating' RO/DO output is switched on for 10 minutes and switched off for 30 minutes.

[Configuration register](#)

[Controller Typ Heating](#)  
 ContrTyp\_Heating\_8003

[Controller Typ Cooling](#)  
 ContrTyp\_Cooling\_8004

**2-point controller (main control loop)**

The controller types for heating and cooling the main control loop can be configured via the **Controller Typ Heating** and **Controller Typ Cooling** parameters.

The following parameters have an influence on the 2-point controller of the main control loop.

Parameter	Holding address	Range
<b>Controller Typ Heating = 2-Point controller</b>		
Manipulated Variable Min. Heating	*1 8015	0...100 % (default: 0 %)
Manipulated Variable Max. Heating	*1 8016	0...100 % (default: 100 %)
<b>Controller Typ Cooling = 2-Point controller</b>		
Manipulated Variable Min. Cooling	*1 8011	0...100 % (default: 0 %)
Manipulated Variable Max. Cooling	*1 8012	0...100 % (default: 100 %)
<b>Heating and Cooling</b>		
Hysteresis Temp Control	8008	0...27.0 °C/°F (default: 1 °C/2 °F)
Manipulated Variable Min. Behavior	*1 8019	0 / 1 (default: 0) 0 = At least the set minimum value is present at the output as heating/cooling power (default) 1 = no effect for the 2-point controller
*1 Parameter is only relevant for units with AO outputs for heating/cooling/6-way valve. The effects of the parameters on the 2-point controller are the same as for the PI controller.		

Tab. 002 Configuring the 2-point controller for main control loop (temperature controller)

The behaviour of the 2-point controller (main control loop) can be illustrated schematically as follows (Fig. 906).

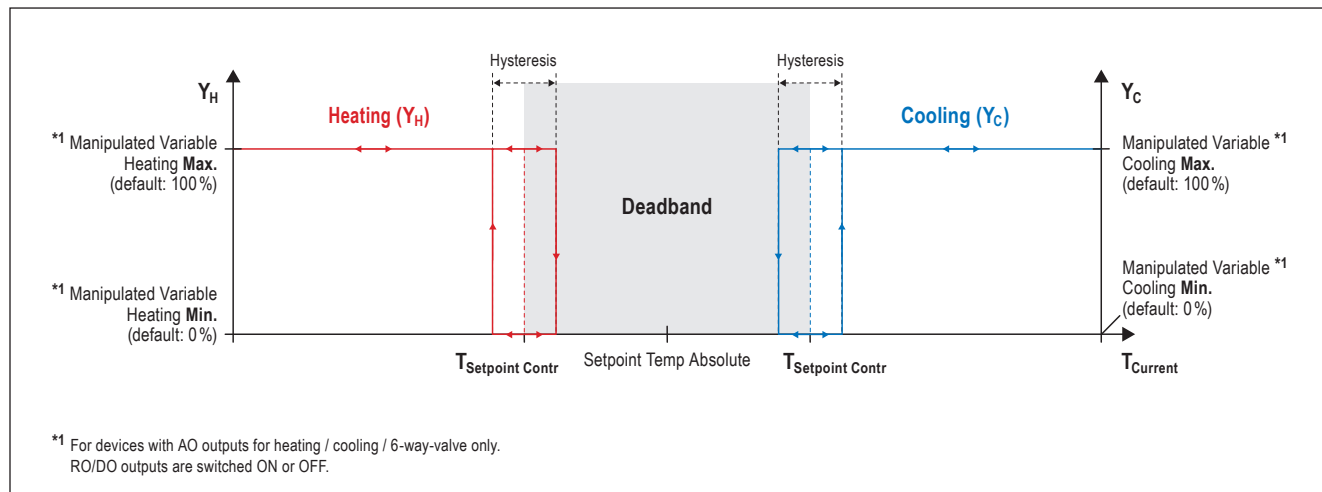

Fig. 906 2-point controller (main control loop) | Manipulated variables ( $Y_H/Y_C$ ) as a function of the setpoint/current temperature

**2-point controller (main control loop)**  
 continued

**Note:**

To ensure trouble-free operation, the controller performs a plausibility check of the two parameters **Dead Band** and **Hysteresis**. The dead band has priority. If a configuration of the two parameters causes the heating/cooling hysteresis ranges to overlap, the hysteresis is automatically adjusted by the unit.

The parameters **Manipulated Variable Max...** and **Manipulated Variable Min...** (refer to **Tab. 002**) can be used to set limit values for units with AO outputs for heating/cooling/6-way valve. This allows the voltage at the output to be limited.

The following diagram shows the example with 'Manipulated Variable Min. Heating = 20%' (**Fig. 907**).

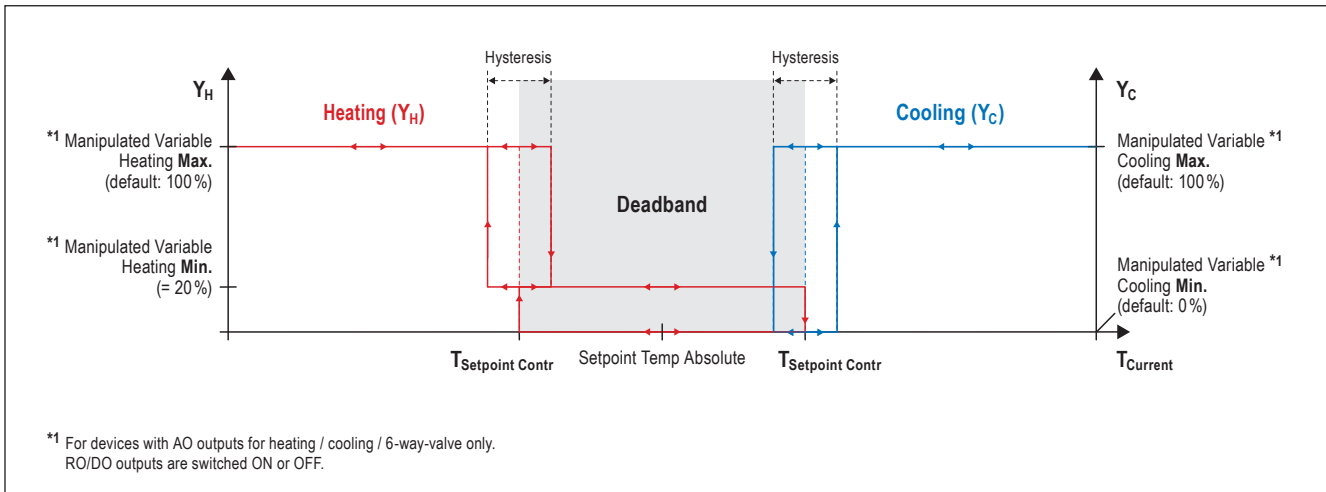

Fig. 907 2-point controller (main control loop) | Manipulated Variable Min. Behavior = 0

**Important for fancoil controllers with AO output for fans**  
 (RYMASKON 143xC / 145xC / 146xC)

If the main control loop (temperature) is set as a 2-point controller and, for example, the configuration is carried out as analogue **Fig. 007** ('Manipulated Variable Min. Heating = 20%' and 'Manipulated Variable Min. Behavior = 0'), the fan switches off at  $T_{Setpoint\ Contr} + \frac{1}{2} Hysteresis$ , whereas a signal can still be present at the output for heating.

[Configuration register](#)

[2. Control Loop Type](#)  
[2.ContrLoopType\\_8044](#)

[2. Control Loop Setpoint Temp Offset](#)  
[2.ContrLoop\\_SetTempOffset\\_8049](#)

[Frost Protection](#)  
[Frost\\_Protection\\_8041](#)

[Heat Protection](#)  
[Heat\\_Protection\\_8042](#)

[2. Control Loop Sensor Mapping](#)  
[2.ContrLoop\\_SensMapping\\_8043](#)

[Data register](#)

[Change-Over Status](#)  
[ChangeOver\\_Status\\_1600](#)

[Temp Setpoint Absolut](#)  
[Setpoint\\_Temp\\_Absolut\\_402](#)

## 9.4.2 Second control loop (temperature controller)

The second control loop is only possible in Change-Over mode (together with the main control loop). Enabling the Change-Over mode is described in Chapter 9.2 'Change-Over'. In addition, the parameter **2. Control Loop Type** must be used to activate the second control loop (PI controller or 2-point controller).

The second control loop is connected to the 'Cooling' output.  
The main control loop remains on the 'Heating' output and '6-way valve'.

The temperature setpoint of the second control loop is paired to the setpoint of the main control loop, but can be shifted with a constant value via the parameter **2. Control Loop Setpoint Temp Offset**.

Since the second control loop is operated exclusively in Change-Over mode (heating or cooling), the dead band is disabled (refer to Chapter 9.1 'Temperature Setpoint (Main control loop)'). An enabled window contact activates the building protection.

This allows the setpoint of the second control loop ( $T_{2,Setpoint}$ ) to be calculated as follows.

If building protection is enabled:

$$T_{2,Setpoint} = \text{Frost Protection} \quad (\text{Heating mode})$$

$$T_{2,Setpoint} = \text{Heat Protection} \quad (\text{Cooling mode})$$

Otherwise:

$$T_{2,Setpoint} = \text{Temp Setpoint Absolut} + \text{2. Control Loop Setpoint Temp Offset} \quad (\text{Heating or cooling mode})$$

The control difference ( $dT_2$ ) is calculated as follows:

$$dT_2 = T_{2,Setpoint} - T_{2,Current}$$

The current temperature ( $T_{2,Current}$ ) for the second control loop is specified via the external temperature sensor or via the bus value.

The assignment is made via the parameter **2. Control Loop Sensor Mapping**.



[Configuration register](#)

[2. Control Loop Type](#)  
[2.ContrLoopType\\_8044](#)

**PI controller (second control loop)**

The controller types of the second control loop can be configured via the parameter **2. Control Loop Type**.

The following parameters have an influence on the PI controller of the second control loop.

Parameter	Holding address	Range
<b>Second control loop</b> is enabled as PI controller if: <b>Change-Over Status</b> = Cooling/Heating <b>2. Control Loop Type</b> = PI controller		
<b>2. Control Loop Sensor Mapping</b>	8043	1 / 2 (default: 1) 1 = external temperature sensor (default) 2 = Bus temperature sensor
<b>2. Control Loop Proportional Band <math>X_p</math></b>	8045	0.1...27.0 °C/°F (default: 2 °C/4 °F)
<b>2. Control Loop Reset Time <math>T_I</math></b>	8046	0...1200 minutes (default: 20 minutes)
<b>2. Control Loop Manipulated Variable Min</b>	8047	0...100% (default: 0%)
<b>2. Control Loop Manipulated Variable Max</b>	8048	0...100% (default: 100%)
<b>2. Control Loop Setpoint Temp Offset</b>	8049	-25.0...25.0 °C/°F (default: 0 °C)
<b>together with main control loop</b>		
<b>Y Min Deviation PI Temp Control Loop</b>	8018	0...10% (default: 0.2%)
<b>Manipulated Variable Min. Behavior</b>	8019	0 / 1 (default: 0) 0 = At least the set minimum value is present at the output as heating/cooling power (default) 1 = Heating/cooling power is only applied to the output from the set min. value.
<b>PWM Cycle Time</b>	8005	5...60 minutes (default: 30 minutes)

Tab. 003 Configuring the PI controller for second control loop (temperature controller)

With the PI controller, the two parameters **2. Control Loop Proportional Band  $X_p$**  and **2. Control Loop Reset Time  $T_I$**  are used to determine the temporal behaviour. Due to the proportional part (P), the manipulated variable reacts immediately to any temperature difference. The integral part (I) acts with time.

**PI controller (second control loop)**  
 continued

The operating principle of the 'Limiter', 'Dynamic Quantisation' and PWM is the same as for the main control loop.

The calculation of the manipulated variable is illustrated in simplified form in the following diagram (Fig. 908). The diagram for the control variable can be derived from it as a function of the setpoint/current temperature. (Fig. 909)

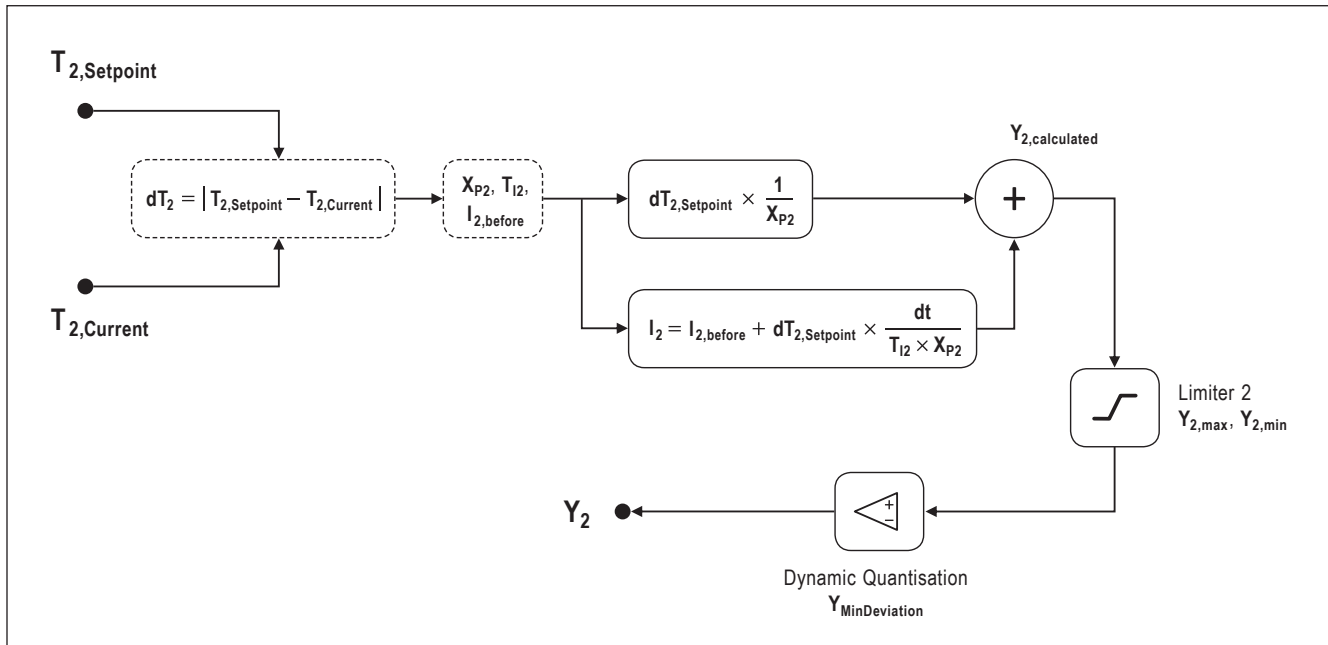

Fig. 908 PI controller (second control loop) | Calculation of the manipulated variable ( $Y_2$ )

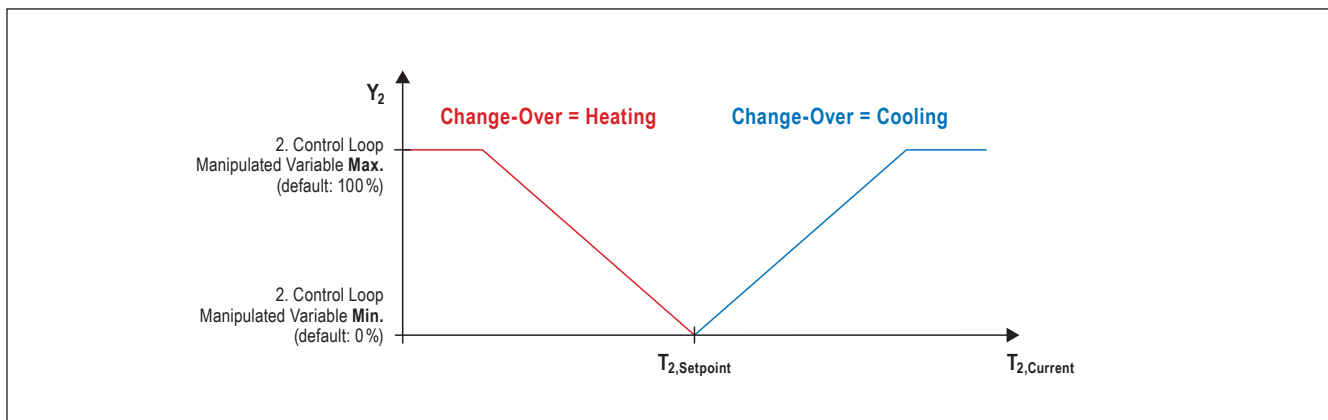

Fig. 909 PI controller (second control loop) | Manipulated variable ( $Y_2$ ) as a function of the setpoint/current temperature

[Configuration register](#)

**2. Control Loop Type**  
 2.ContrLoopType\_8044

**2-point controller (second control loop)**

The following parameters have an influence on the 2-point controller of the second control loop.

Parameter	Holding address	Range
<b>Second control loop</b> is enabled as 2-point controller if: <b>Change-Over Status</b> = Cooling/Heating <b>2. Control Loop Type</b> = 2-Point controller		
<b>2. Control Loop Sensor Mapping</b>	8043	1 / 2 (default: 1) 1 = external temperature sensor (default) 2 = Bus temperature sensor
<b>2. Control Loop Manipulated Variable Min</b> *1	8047	0...100 % (default: 0 %)
<b>2. Control Loop Manipulated Variable Max</b> *1	8048	0...100 % (default: 100 %)
<b>2. Control Loop Setpoint Temp Offset</b>	8049	-25.0...25.0 °C/°F (default: 0 °C)
<b>together with main control loop</b>		
<b>Hysteresis Temp Control</b>	8008	0...27.0 °C/°F (default: 1 °C)
<b>Manipulated Variable Min. Behavior</b> *1	8019	0 / 1 (default: 0) 0 = At least the set minimum value is present at the output as heating/cooling power (default) 1 = no effect for the 2-point controller
*1 Parameter is only relevant for units with AO outputs for heating/cooling. The effects of the parameters on the 2-point controller are the same as for the PI controller.		

Tab. 004 Configuring the 2-point controller for second control loop (temperature controller)

The behaviour of the 2-point controller (second control loop) can be illustrated schematically as follows (Fig. 910).

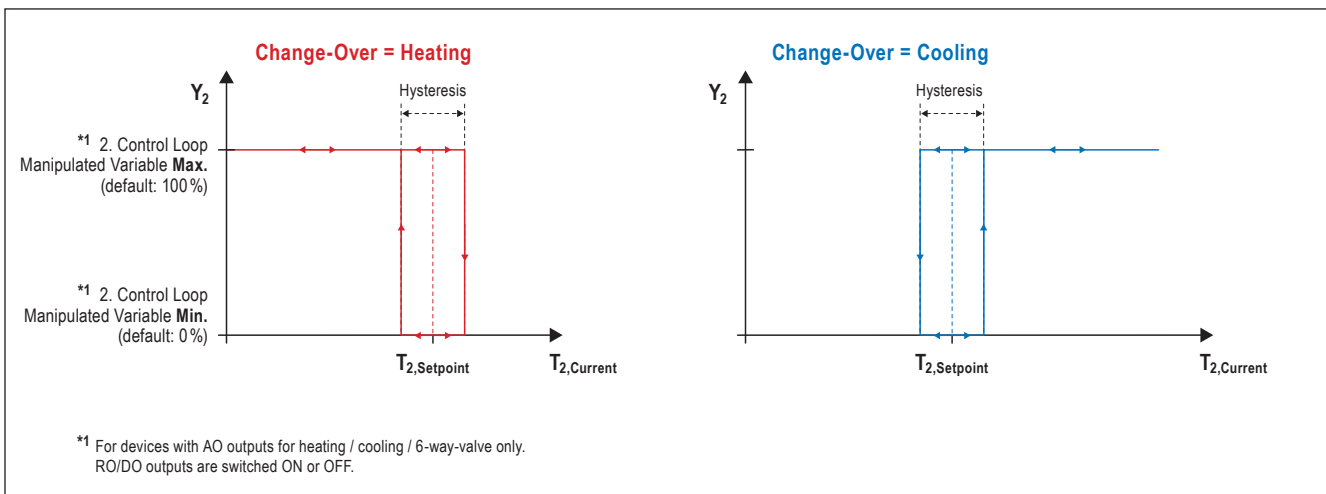

Fig. 910 2-point controller (second control loop) | Manipulated variable ( $Y_2$ ) as a function of the setpoint/current temperature

The parameters **2. Control Loop Manipulated Variable Max** and **2. Control Loop Manipulated Variable Min** (refer to **Tab. 004**) can be used to set the limits for the AO output of the 2nd control loop. This allows the voltage at the output to be limited.

[Configuration register](#)

**Fan Mapping**

FanMapping\_8031

**AO Fan Min.**

AO\_FanMin\_8032

**AO Fan Max.**

AO\_FanMax\_8033

**Number of Fan Steps**

Fan\_NumberOfSteps\_3762

[Data register](#)

**Fan Level**

Setpoint\_Fan\_Level\_407

## 9.5 Fan control

Only for type RYMASKON 143xC / 144xC / 145xC / 146xC (fancoil controller)

The parameter **Fan Mapping** can be used to configure the fan operating mode.

By default, the fan responds to the heating or cooling power (refer to Chapter 9.5.1 'Heating/cooling fan control (Fancoil, Auto)').

Alternatively, it can be configured to control RH, CO2 or VOC concentration (refer to Chapter 9.5.2 'Fan control RCV (Auto)').

### Fan Mapping

The parameter **Fan Mapping** can be used to configure the fan operating mode.

The general function of the configuration options can be divided into two groups:

- **Fan Mapping = 1...3**  
In automatic mode, the fan responds to the control deviation of the current temperature
- **Fan Mapping = 4...9**  
The RCV controller is enabled  
(refer to Chapter 9.5.2 'Fan control RCV (Auto)')

The RYMASKON® 1000 Controller series has two different output types for controlling a fan:

- AO output (0...10 V)**  
for controlling an **EC fan**  
RYMASKON 143xC (1x AO for fan)  
RYMASKON 145xC (1x AO for fan)  
RYMASKON 146xC (2x AO for fan, running in parallel)
- RO outputs (3 relays)**  
for controlling a **3-level fan**  
RYMASKON 144xC (3x RO for fan, 230V, max. 3A)

### Manual fan control (Manual mode)

The user interface of the fan control and the configuration options of the Controller for Manual mode are described in Chapter 4.X 'Fan'.

In Auto mode, the Controller controls the fan outputs depending on the heating/cooling or RCV controller. Manually adjusting the fan levels to OFF or to fan level 1...5 results in the controller being decoupled from the fan outputs.

The control of the fan output in Manual mode differs between AO output (EC fan, 0-10 V) and RO output (3 relays).

The three relays of the RYMASKON 144xC are switched according to the manually set fan level.

The voltage at the AO output of the RYMASKON 143xC, 145xC and 146xC is calculated as follows:

$$AO_{FM} = AO \text{ Fan Min.} + \frac{\text{Fan Level}}{\text{Number of Fan Steps}} \times (AO \text{ Fan Max.} - AO \text{ Fan Min.})$$

[Configuration register](#)

**Number of Fan Steps**  
Fan\_NumberOfSteps\_3762

**Fan Mapping**  
FanMapping\_8031

**Fan StartUp Time**  
Fan\_StartUpTime\_8035

**Fan FollowUp Time**  
Fan\_FollowUpTime\_8036

**Hysteresis Temp Control**  
Hyst\_TempContr\_8008

**Fan Gradient AO**  
FanGradient\_AO\_8037

**AO Fan Min.**  
AO\_FanMin\_8032

**AO Fan Max.**  
AO\_FanMax\_8033

**Fan Manipulated Variable Start**  
Fan\_ManipVar\_Start\_8034

[Data register](#)

**Fan Level**  
Setpoint\_Fan\_Level\_407

### 9.5.1 Heating/cooling fan control (Fancoil, Auto)

This section provides a description of the fan control when the fan responds to the heating or cooling power in automatic mode. The configuration options via the **Fan Mapping** parameter are as follows:

- **Fan Mapping = 1** → Fan responds to cooling and heating
- **Fan Mapping = 2** → Fan responds to cooling
- **Fan Mapping = 3** → Fan responds to heating

**Basic functions of fan control**  
(valid for all types of Controllers)

- In automatic mode (406 = 1), the fan control is paired with the main control loop (temperature controller).
- If no heating or cooling power is required in the fan's automatic mode ( $Y_H$  and  $Y_C = 0\%$ ), the fan level  $Y_F = 0\%$  (default: if  $Y_F = 0\%$ , the fan is turned off).
- The fan can be configured to start up more reliably using the **Fan StartUp Time** parameter. During this time, the fan runs from standstill to maximum speed.
- The fan shut down can be delayed using the **Fan FollowUp Time** parameter.

**Behaviour of controller with AO output for fans (0..10V)**  
(RYMASKON 143xC / 145xC / 146xC)

If the controller type for heating/cooling is configured to PI controller, the manipulated variable of the fan ( $Y_F$ ) changes according to the manipulated variables for heating/cooling ( $Y_H / Y_C$ ).

$$Y_F = Y_H \quad \text{or} \quad Y_F = Y_C$$

if the heating/cooling controller type is configured to 2-point controller, the manipulated variable of the fan ( $Y_F$ ) is calculated from the control deviation and the proportional range **Fan Gradient AO** as follows:

$$Y_F = \left| \frac{T_{\text{Setpoint Contr}} - T_{\text{Current}} + \frac{\text{Hysteresis Temp Control}}{2}}{\text{Fan Gradient AO}} \right| \times 100\%$$

The value for  $T_{\text{Setpoint Contr}}$  and  $T_{\text{Current}}$  depends on the operating mode and configuration (refer to Chapter 9.1 'Temperature Setpoint (Main control loop)' and 3.1 'Current temperature').

Additional configuration options:

- The min/max value of the fan output can be configured via the **AO Fan Min.** [V] and **AO Fan Max.** [V] parameters (e.g.  $Y_F = 0 \dots 100\% \hat{=} 2.0 \dots 8.0V$ ).  
If, for example, **AO Output Min.** > 0V is set, the fan also runs at  $Y_F = 0\%$ .
- The manipulated variable at which the fan should start can be configured via the **Fan Manipulated Variable Start** parameter.  
If, for example, **Fan Manipulated Variable Start** = 20% is set, the fan only starts at  $Y_F \geq 20\%$ .

Fan Auto Mode (406=1)		Number of Fan Steps (3762)				
		1	2	3	4	5
Display Fan Level (407)	0 (off)	$Y_F = 0\%$	$Y_F = 0\%$	$Y_F = 0\%$	$Y_F = 0\%$	$Y_F = 0\%$
	1	$Y_F > 0\%$	$Y_F > 0\%$	$Y_F > 0\%$	$Y_F > 0\%$	$Y_F > 0\%$
	2		$Y_F > 50\%$	$Y_F > 33\%$	$Y_F > 25\%$	$Y_F > 20\%$
	3			$Y_F > 66\%$	$Y_F > 50\%$	$Y_F > 40\%$
	4				$Y_F > 75\%$	$Y_F > 60\%$
	5					$Y_F > 80\%$

Tab. 005 Fan level ( $Y_F$ ) and fan level display for controllers that have an AO output for fans

[Configuration register](#)

**Number of Fan Steps**

Fan\_NumberOfSteps\_3762

**Fan Manipulated Variable Start**

Fan\_ManipVar\_Start\_8034

**Delta T Fan Level 1 RO**

DeltaT\_FanLevel1RO\_8038

**Delta T Fan Level 2 RO**

DeltaT\_FanLevel2RO\_8039

**Delta T Fan Level 3 RO**

DeltaT\_FanLevel3RO\_8040

**Behaviour of Controller with RO output for fans (3 relays)**

(RYMASKON 144xC)

If the controller type for heating/cooling is configured to PI controller, the manipulated variable of the fan ( $Y_F$ ) changes according to the manipulated variables for heating/cooling ( $Y_H / Y_C$ ).

$$Y_F = Y_H \quad \text{or} \quad Y_F = Y_C$$

The fan levels are switched via a fixed threshold of the manipulated variable  $Y_F$ .

The thresholds depend on the number of fan levels (refer to **Tab. 006**).

The number is configured via the **Number of Fan Steps** parameter.

PI control (main control loop)		Number of Fan Steps (3762)		
		1	2	3
Display Fan Level (407)	1	$Y_F > 0\%$	$Y_F > 0\%$	$Y_F > 0\%$
	2		$Y_F > 50\%$	$Y_F > 33\%$
	3			$Y_F > 66\%$

Tab. 006 Fan level ( $Y_F$ ) and fan level display for controllers that have an RO output for 3-level fans (RYMASKON 144xC)

The manipulated variable at which the fan should start can be configured via the **Fan Manipulated Variable Start** parameter.

If, for example, **Fan Manipulated Variable Start** = 30 % is set, the fan only starts at  $Y_F \geq 30\%$ .

If the heating/cooling controller type is configured as a 2-point controller, the fan levels are switched via the temperature difference between the setpoint temperature and the current temperature.

The configuration of the switching thresholds ( $dTL_{F1}$ ,  $dTL_{F2}$ ,  $dTL_{F3}$ ) takes place via the parameters **Delta T Fan Level 1 RO**, **Delta T Fan Level 2 RO** and **Delta T Fan Level 3 RO**.

The internal hysteresis (permanently programmed to  $\pm 0.3\text{ °C} / \text{°F}$ ) prevents the outputs from jittering when the fan levels are switched (**Fig. 911**).

If 0 (default) is set for **Delta T Fan Level 1 RO** ( $dTL_{F1}$ ),

the fan starts immediately when a heating or cooling request occurs ( $Y_H$  or  $Y_C > 0\%$ ).

The internal hysteresis has no influence on the switching threshold  $dTL_{F1}$ .

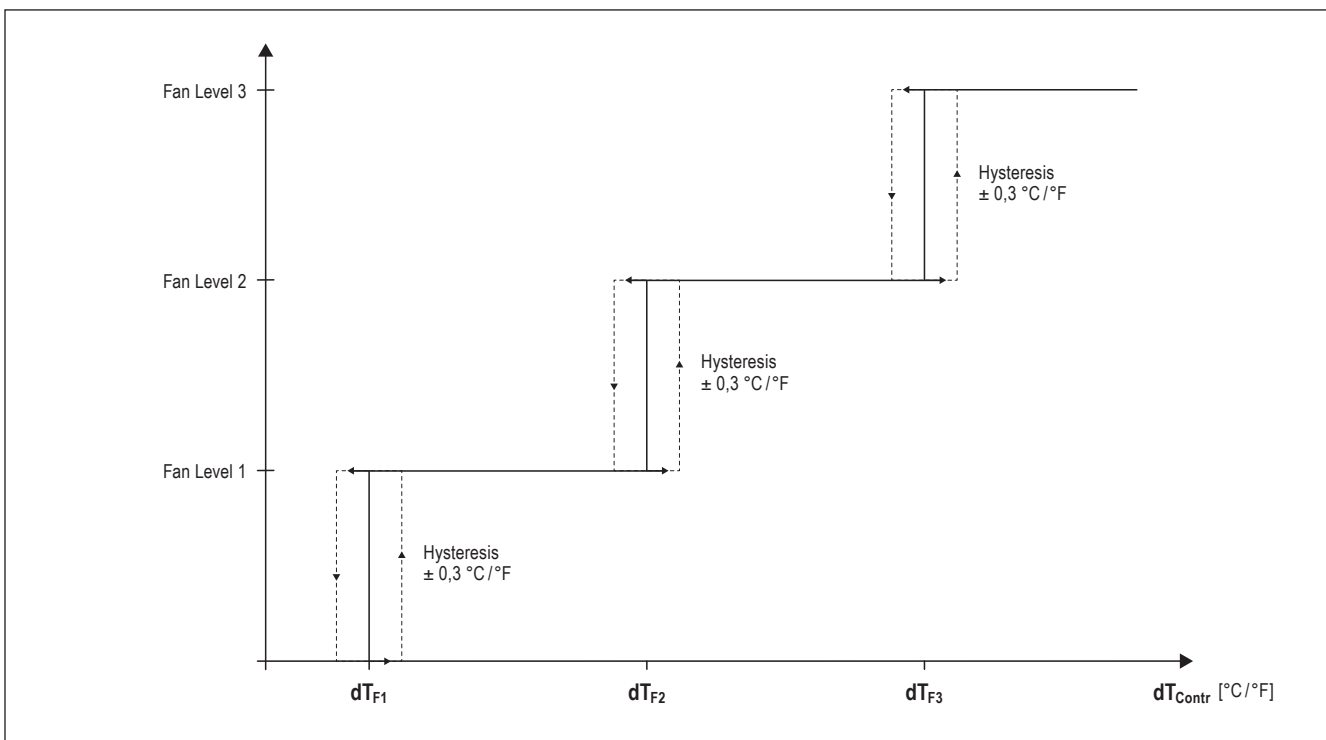

Fig. 911 RYMASKON 144xC (3-level fan) when connected to a 2-point temperature control

[Configuration register](#)

**Fan Mapping**

FanMapping\_8031

**Control Type RCV**

ContrTyp\_RCV\_8201

**Setpoint RCV**

Setpoint\_RCV\_8200

**Fan StartUp Time**

Fan\_StartUpTime\_8035

**Fan FollowUp Time**

Fan\_FollowUpTime\_8036

[Data register](#)

**Humidity Sensor 1 Int.**

HumS1Int\_Value\_101

**CO2 Sensor 1 Int.**

CO2S1Int\_Value\_102

**9.5.2 Fan control RCV (Auto)**

The AO/RO outputs for controlling a fan can be used to regulate the RH, CO2 or VOC concentration in the room.

The **Fan Mapping** parameter is used to assign the desired measurand to the 3rd control loop (fan RCV control).

The RCV controller is enabled when an RH, CO2 or VOC sensor is assigned.

The controller type is configured via the **Control Type RCV** parameter.

The setpoint is permanently configured via the **Setpoint RCV** parameter and cannot be changed on the unit during operation.

The control difference (**dRCV**) is calculated as follows:

$$\mathbf{dRCV = Setpoint\ RCV - RCV_{Current}}$$

The value for **RCV<sub>Current</sub>** depends on the assigned sensor via the **Fan Mapping** parameter.

**Important!**

The control sequence of the RCV is unidirectional.

RH: Dehumidification

CO2 / VOC: Fresh air supply

It is not possible to humidify or enrich the air with CO2/VOC!

Example 1:

<b>Fan Mapping</b>	=	humidity (internal sensor)
<b>RCV<sub>Current</sub></b>	=	<b>Humidity Sensor 1 Int.</b> = <b>800</b> (80 %RH)
<b>RCV<sub>Setpoint</sub></b>	=	<b>Setpoint RCV</b> = <b>500</b> (50 %RH)

→ **RCV<sub>Setpoint</sub> < RCV<sub>Current</sub>** → fan is activated

Example 2:

<b>Fan Mapping</b>	=	humidity (internal sensor)
<b>RCV<sub>Current</sub></b>	=	<b>Humidity Sensor 1 Int.</b> = <b>500</b> (50 %RH)
<b>RCV<sub>Setpoint</sub></b>	=	<b>Setpoint RCV</b> = <b>800</b> (80 %RH)

→ **RCV<sub>Setpoint</sub> > RCV<sub>Current</sub>** → fan is not activated

Example 3:

<b>Fan Mapping</b>	=	CO2 (internal sensor)
<b>RCV<sub>Current</sub></b>	=	<b>CO2 Sensor 1 Int.</b> = <b>1500</b> (1500 ppm)
<b>RCV<sub>Setpoint</sub></b>	=	<b>Setpoint RCV</b> = <b>800</b> (800 ppm)

→ **RCV<sub>Setpoint</sub> < RCV<sub>Current</sub>** → fan is activated

**Fan StartUp Time / FollowUp Time**

To ensure that the fan starts up safely, a start-up time can be configured via the **Fan StartUp Time** parameter (default: 1s). During this time, the fan runs from standstill to maximum speed.

The **Fan FollowUp Time** parameter (default: 1s) can be used to delay the fan shut down.

**PI controller (RCV control loop)**

The RCV controller type can be configured via the **Control Type RCV** parameter.  
 The following parameters have an influence on the PI controller of the RCV control loop.

Configuration register

**Fan Mapping**

FanMapping\_8031

**Control Type RCV**

ContrTyp\_RCV\_8201

**Setpoint RCV**

Setpoint\_RCV\_8200

Data register

**Humidity Sensor 1 Int.**

HumS1Int\_Value\_101

**CO2 Sensor 1 Int.**

CO2S1Int\_Value\_102

Parameter	Holding address	Range	
<b>Control Type RCV = PI controller</b>			
<b>Setpoint RCV</b>	8200	0...30 000	(default: 1000)
<b>Proportional Band <math>X_p</math> RCV</b>	8202	0...10 000	(default: 100)
<b>Reset Time <math>T_I</math> RCV</b>	8203	0...60 000 s	(default: 420 s)
<b>Fan Manipulated Variable Start</b>	8034	0...30 %	(default: 0 %)
<b>RCV Min Deviation PI Control Loop</b>	8209	0...50 %	(default: 5 %)

Tab. 007 Configuring the PI controller for RCV control loop (fan)

With the PI controller, the temporal behaviour is determined via the two parameters **Proportional Band  $X_p$  RCV** and **Reset Time  $T_I$  RCV**.

Due to the proportional part (P), the manipulated variable reacts immediately to any RCV difference. The integral part (I) acts with time. The resulting manipulated variable ( $Y_{RCV}$ ) is applied as a continuous signal to an AO fan output.

The calculation of the manipulated variable is illustrated in simplified form in the following diagram (Fig. 912). The diagrams for the manipulated variable can be derived from this as a function of the Setpoint/Current RCV (see Fig. 913 / Fig. 914).

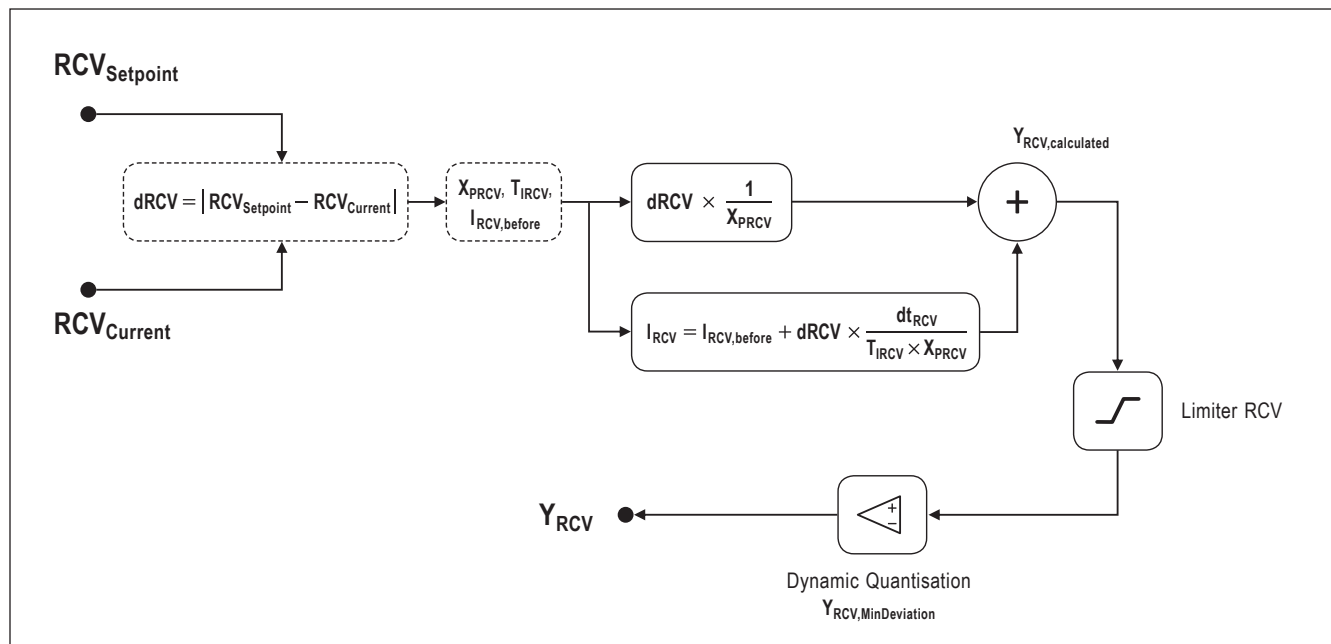

Fig. 912 PI controller (RCV control loop) | Calculation of the manipulated variable ( $Y_{RCV}$ )

The 'Limiter RCV' is configured via the **Fan Manipulated Variable Start** parameter (refer to Fig. 912 and Tab. 007).

The 'Dynamic Quantisation' is configured via the  **$Y_{RCV}$  Min Deviation PI Control Loop** parameter (refer to Fig. 912 and Tab. 007).

In this process, the calculated manipulated variable is compared with the previous manipulated variable. If the deviation is less than the value from the  **$Y_{RCV}$  Min Deviation PI Control Loop** parameter, the manipulated variable does not change.



PI controller (RCV control loop)  
continued

The following diagrams for the manipulated variable as a function of the Setpoint/Current RCV illustrate examples with 'Fan Manipulated Variable Start = 0% (default)' (Fig. 913) as well as 'Fan Manipulated Variable Start = 20%' (Fig. 914).

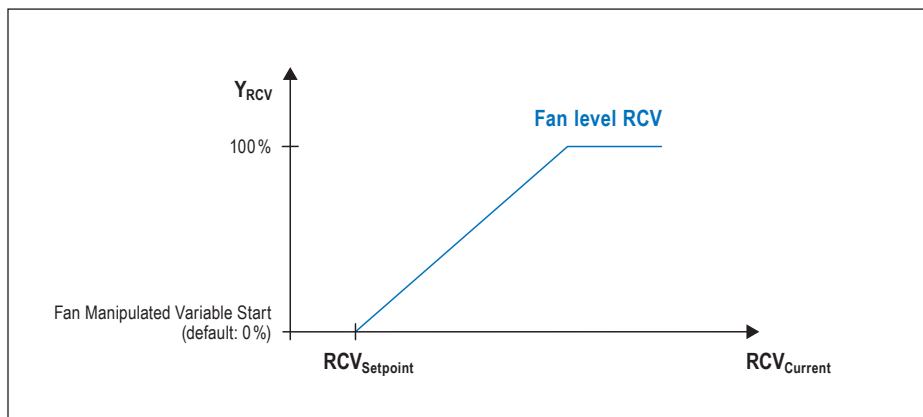

Fig. 913 PI controller (RCV control loop) | Manipulated variable ( $Y_{RCV}$ ) as a function of the Setpoint/Current RCV

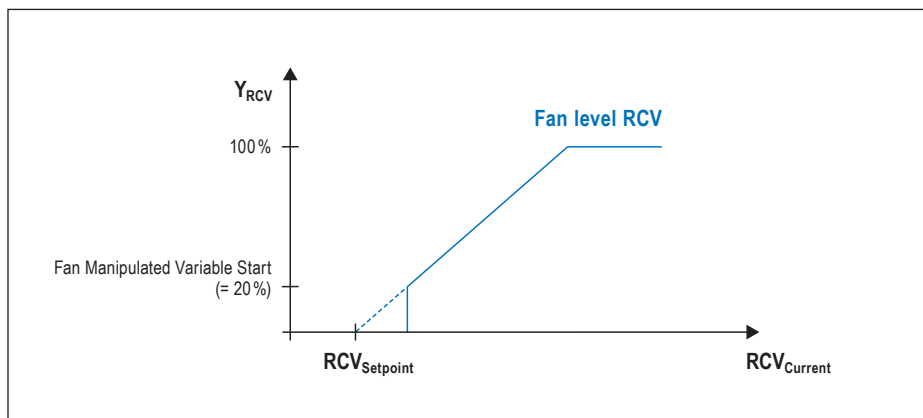

Fig. 914 PI controller (RCV control loop) | Fan Manipulated Variable Start = 20%

**2-point controller (RCV control loop)**

The RCV controller type can be configured via the **Control Type RCV** parameter.

The following parameters have an influence on the 2-point controller of the RCV control loop (**Tab. 008**).

Configuration register

**Number of Fan Steps**  
 Fan\_NumberOfSteps\_3762

**Control Type RCV**  
 ContrTyp\_RCV\_8201

**AO Fan Min.**  
 AO\_FanMin\_8032

**AO Fan Max.**  
 AO\_FanMax\_8033

Parameter	Holding address	Range	
<b>Control Type RCV = 2-Point controller</b>			
<b>Setpoint RCV</b>	<b>8200</b>	0...30 000	(default: 1000)
<b>Hysteresis RCV</b>	<b>8204</b>	0...30 000	(default: 50)

Tab. 008 Configuring the 2-point controller for RCV control loop (fan)

Data register

**Fan Level**  
 Setpoint\_Fan\_Level\_407

The behaviour of the 2-point controller (RCV control loop) can be illustrated schematically as follows (**Fig. 915**).

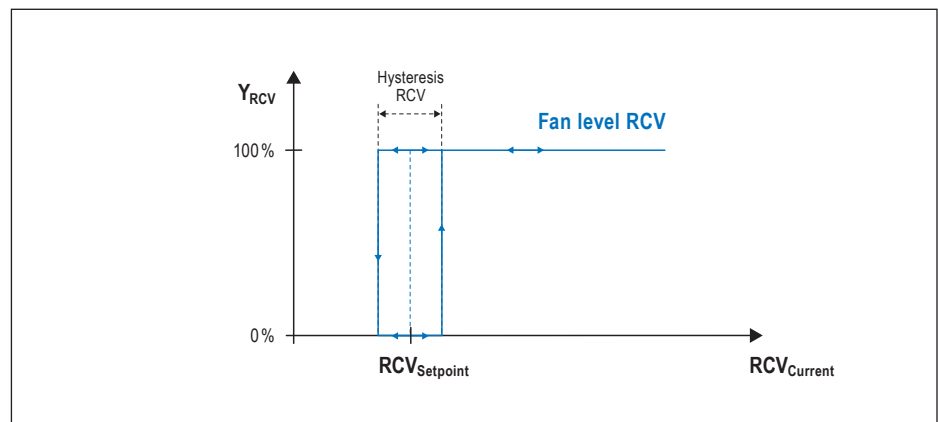

Fig. 915 2-point controller (RCV control loop) | Manipulated variable ( $Y_{RCV}$ ) as a function of the Setpoint/Current RCV

**Behaviour of controller with AO output for fans (0...10V) for RCV control**  
 (RYMASKON 143xC / 145xC / 146xC)

The min/max value of the fan output can be configured via the

**AO Fan Min.** [V] and **AO Fan Max.** [V] parameters

(e.g.  $Y_{RCV} = 0...100\% \hat{=} 2.0...8.0V$ ).

If, for example, **AO Output Min.** > 0V is set, the fan also runs at  $Y_{RCV} = 0\%$ .

Fan Auto Mode (406=1)		Number of Fan Steps (3762)				
		1	2	3	4	5
Display Fan Level (407)	0 (off)	$Y_{RCV} = 0\%$	$Y_{RCV} = 0\%$	$Y_{RCV} = 0\%$	$Y_{RCV} = 0\%$	$Y_{RCV} = 0\%$
	1	$Y_{RCV} > 0\%$	$Y_{RCV} > 0\%$	$Y_{RCV} > 0\%$	$Y_{RCV} > 0\%$	$Y_{RCV} > 0\%$
	2		$Y_{RCV} > 50\%$	$Y_{RCV} > 33\%$	$Y_{RCV} > 25\%$	$Y_{RCV} > 20\%$
	3			$Y_{RCV} > 66\%$	$Y_{RCV} > 50\%$	$Y_{RCV} > 40\%$
	4				$Y_{RCV} > 75\%$	$Y_{RCV} > 60\%$
	5					$Y_{RCV} > 80\%$

Tab. 009 Fan level ( $Y_{RCV}$ ) and fan level display for controllers that have an AO output for fans

**2-point controller (RCV control loop)**  
 continued

[Configuration register](#)

**Setpoint RCV**

Setpoint\_RCV\_8200

**Fan Mapping**

FanMapping\_8031

**Delta RCV Fan Level 1 RO**

DeltaRCV\_FanLevel1RO\_8205

**Delta RCV Fan Level 2 RO**

DeltaRCV\_FanLevel2RO\_8206

**Delta RCV Fan Level 3 RO**

DeltaRCV\_FanLevel3RO\_8207

**Behaviour of controller with RO output for fans (3 relays) for RCV control**  
 (RYMASKON 144xC)

The three relays of the RYMASKON 144xC are controlled via switching thresholds in RCV control (independent of PI or 2-point control).

The fan levels are switched via the RCV difference (**dRCV**) between **Setpoint RCV** and the assigned sensor value of the RCV control.

The RCV difference (**dRCV**) is calculated as follows:

$$\mathbf{dRCV = Setpoint\ RCV - RCV_{Current}}$$

**RCV<sub>Current</sub>** depends on the sensor assigned via the **Fan Mapping** parameter.

The configuration of the switching thresholds (**dRCV<sub>F1</sub>**, **dRCV<sub>F2</sub>**, **dRCV<sub>F3</sub>**) takes place via the parameters **Delta RCV Fan Level 1 RO**, **Delta RCV Fan Level 2 RO** and **Delta RCV Fan Level 3 RO**.

The hysteresis can be configured via the **Hysteresis RCV Control** parameter to prevent the outputs from jittering when the fan levels are changed (Fig. 916).

When 0 (default) is set for **Delta RCV Fan Level 1 RO** (**dRCV<sub>F1</sub>**), the fan starts directly at **dRCV > 0**.

The internal hysteresis has no influence on the switching threshold **dRCV<sub>F1</sub>**.

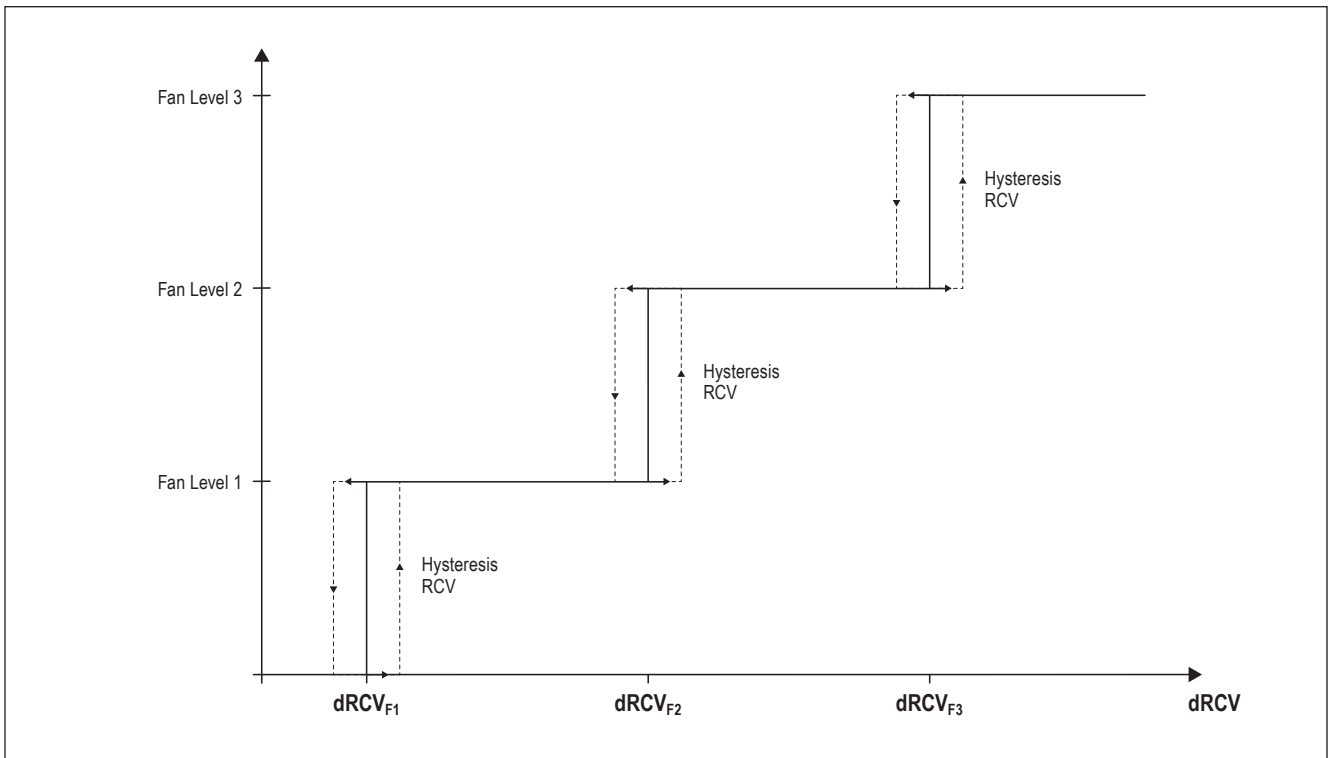

Fig. 916 RYMASKON 144xC (3-level fan) when connected to a 2-point RCV control

### Configuration register

**AO Direction Heating**  
AODirection\_Heating\_8025

**AO Direction Cooling**  
AODirection\_Cooling\_8026

**RODO Direction Heating**  
RODDirection\_Heating\_8027

**RODO Direction Cooling**  
RODDirection\_Cooling\_8028

**Output 6-Way-Valve**  
Out6WayValve\_8020

**6-Way-Valve Generic...**  
6WayValveGen...\_8021 bis  
6WayValveGen...\_8024

### Data register

**AO Output Heating BMS Contr.**  
AO\_OutHeat\_BMSContr\_1608

**AO Output Cooling BMS Contr.**  
AO\_OutCool\_BMSContr\_1609

**AO Output 6-Way-Valve BMS Contr.**  
AO\_Out6WayValve\_BMSContr\_1610

**RO/DO Output Heating BMS Contr.**  
RODO\_OutHeat\_BMSContr\_1611

**RO/DO Output Cooling BMS Contr.**  
RODO\_OutCool\_BMSContr\_1612

**AO Output Fan BMS Contr.**  
AO\_OutFan\_BMSContr\_1613

**RO/DO Output Fan BMS Contr.**  
RODO\_OutFan\_BMSContr\_1615

**Fan Auto Mode**  
Fan\_AutoMode\_406

**Fan Level**  
Setpoint\_Fan\_Level\_407

## 9.6 Outputs

The assignment of the functions to the outputs is permanently stored in the Controller. For example, a heating output cannot be configured to control a fan.

The output designations are as follows:

- Heating (AO/DO/RO)
- Cooling (AO/DO/RO)
- 6-Way Valve (AO)
- Fan (AO/RO)

The BMS can override every individual output.

The **Output...BMS Contr.** parameters are available for this purpose.

If an output is overridden by the BMS, the outputs are decoupled from the controller.

Note for RYMASKON 136xC / 146xC:

The DO outputs are designed for max. 24 V!

The fan outputs are a special case when the BMS overrides the outputs.

If the **AO Output Fan BMS Contr.** (AO fan outputs)

or **RO/DO Output Fan BMS Contr.** (RO fan outputs) parameters are used to override the outputs via the BMS, the display must also be adjusted via the **Fan Auto Mode** and **Fan Level** parameters.

The unit's fan keys remain enabled. Pressing the keys leads to a change on the display and in the parameters, but it does not alter the fan outputs.

### Automatic calibration

To make sure the voltage is accurate, the outputs perform an automatic calibration each time the unit is switched on.

During calibration (takes approx. 0.5 s), the outputs switch to 10 V for 0.1 s and then to 0 V again.

The respective output value is then set.

### Heating and cooling direction

The direction for all heating and cooling outputs can be adjusted.

This allows the control of valves that are normally closed or normally open (NC/NO actuators).

Configuration register

**AO Direction Heating**  
 AODirection\_Heating\_8025

**AO Direction Cooling**  
 AODirection\_Cooling\_8026

**RODO Direction Heating**  
 RODODirection\_Heating\_8027

**RODO Direction Cooling**  
 RODODirection\_Cooling\_8028

**Output 6-Way-Valve**  
 Out6WayValve\_8020

**6-Way-Valve Generic...**  
 6WayValveGen...\_8021 bis  
 6WayValveGen...\_8024

Data register

**AO Output Heating BMS Contr.**  
 AO\_OutHeat\_BMSContr\_1608

**AO Output Cooling BMS Contr.**  
 AO\_OutCool\_BMSContr\_1609

**AO Output 6-Way-Valve BMS Contr.**  
 AO\_Out6WayValve\_BMSContr\_1610

**RO/DO Output Heating BMS Contr.**  
 RODO\_OutHeat\_BMSContr\_1611

**RO/DO Output Cooling BMS Contr.**  
 RODO\_OutCool\_BMSContr\_1612

**AO Output Fan BMS Contr.**  
 AO\_OutFan\_BMSContr\_1613

**RO/DO Output Fan BMS Contr.**  
 RODO\_OutFan\_BMSContr\_1615

**Fan Auto Mode**  
 Fan\_AutoMode\_406

**Fan Level**  
 Setpoint\_Fan\_Level\_407

**9.6.1 Heating and cooling output (AO/DO/RO)**

The controller output variable of the main and second control loop is the manipulated variable **Y** in the range of 0...100% for PI controllers or 0 / 100% for 2-point controllers.

The relationships between manipulated variable and AO/DO/RO output heating and cooling, as well as the influence of the **Manipulated Variable Min**, **Manipulated Variable Min. Behavior** and **Manipulated Variable Max** parameters are illustrated in **Fig. 917**.

The Output 6-way valve is described separately (see chapter 9.6.3).

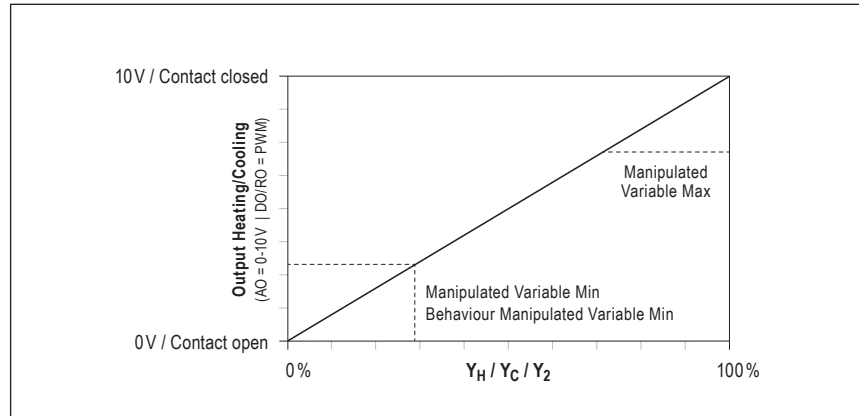

Fig. 917 AO/DO output | Temp controller ( $Y_H/Y_C/Y_2$ ) manipulated variable (default: non-inverted)

**9.6.2 Fan output (AO)**

The controller output variable of the fan control loop is the manipulated variable **Y** in the range of 0...100% for PI controllers or 0 / 100% for 2-point controllers.

The relationships between the manipulated variable and the fan AO output, as well as the influence of the **Fan Manipulated Variable Start** parameter, are illustrated in **Fig. 918**.

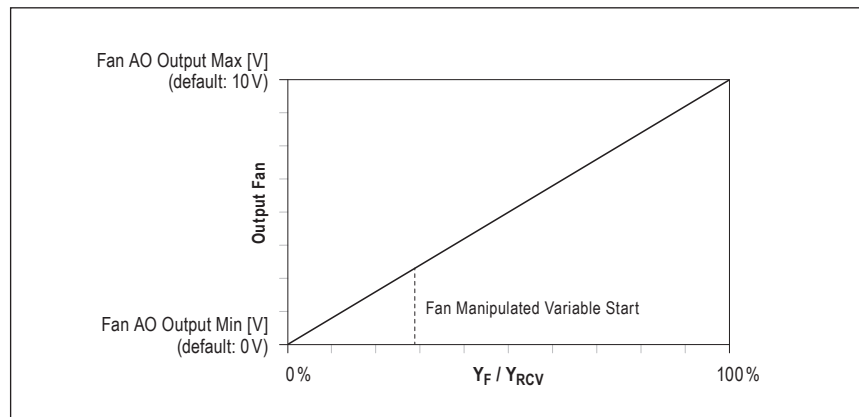

Fig. 918 AO output | Fan control ( $Y_F/Y_{RCV}$ ) manipulated variable (default: non-inverted)

[Configuration register](#)

**Output 6-Way-Valve**  
Out6WayValve\_8020

**6-Way-Valve Generic...**  
6WayValveGen...\_8021 bis  
6WayValveGen...\_8024

[Data register](#)

**AO Output Heating BMS Contr.**  
AO\_OutHeat\_BMSContr\_1608

**AO Output Cooling BMS Contr.**  
AO\_OutCool\_BMSContr\_1609

**AO Output 6-Way-Valve BMS Contr.**  
AO\_Out6WayValve\_BMSContr\_1610

**RO/DO Output Heating BMS Contr.**  
RODO\_OutHeat\_BMSContr\_1611

**RO/DO Output Cooling BMS Contr.**  
RODO\_OutCool\_BMSContr\_1612

**AO Output Fan BMS Contr.**  
AO\_OutFan\_BMSContr\_1613

**RO/DO Output Fan BMS Contr.**  
RODO\_OutFan\_BMSContr\_1615

### 9.6.3 Output 6-way valve (AO)

The **Output 6-way valve** parameter can be used to select various preconfigured 6-way valve types.

It is also possible to configure a generic 6-way valve using the **6-Way Valve Generic...** parameter.

The 6-way valve is disabled on delivery.

Some RYMASKON Controller types do not have their own 6-way valve output and are assigned to the heating or cooling output.

These outputs continue to be overridden via the **AO Output Heating BMS Contr.** or **AO Output Cooling BMS Contr.** parameters, even if these outputs are configured as a 6-way valve.

Configuration options for the preset 6-way valves are listed in the following table (Tab. 011).

The following graphical representations were created in line with the data sheet issued by the manufacturer of the respective 6-way valve (Fig. 919 - 924).

Output 6-way valve adresse 8020	Cooling mode	Heating mode
<b>0</b> (default)	Output 6-Way Valve responds to the heating or cooling output (in both cases) as a steady signal <b>0...10 V</b> .	
<b>1</b> (generic)	100%...0% $\hat{=}$ values from 8021...8022 [V]	0%...100% $\hat{=}$ values from 8023...8024 [V]
<b>2</b> (Belimo)	100%...0% $\hat{=}$ <b>2.0...4.7 V</b>	0%...100% $\hat{=}$ <b>7.3...10 V</b>
<b>3</b> (Belimo inverted)	0%...100% $\hat{=}$ <b>7.3...10 V</b>	100%...0% $\hat{=}$ <b>2.0...4.7 V</b>
<b>4</b> (Sauter DN15)	100%...0% $\hat{=}$ <b>1.1...3.7 V</b>	0%...100% $\hat{=}$ <b>6.3...8.9 V</b>
<b>5</b> (Sauter DN15 inverted)	0%...100% $\hat{=}$ <b>6.3...8.9 V</b>	100%...0% $\hat{=}$ <b>1.1...3.7 V</b>
<b>6</b> (Sauter DN20)	100%...0% $\hat{=}$ <b>1.6...4.5 V</b>	0%...100% $\hat{=}$ <b>5.5...8.4 V</b>
<b>7</b> (Sauter DN20 inverted)	0%...100% $\hat{=}$ <b>5.5...8.4 V</b>	100%...0% $\hat{=}$ <b>1.6...4.5 V</b>
<b>8</b>	Output 6-Way-Valve responds to heating power	100%...0% $\hat{=}$ <b>0...10 V</b>
<b>9</b>	100%...0% $\hat{=}$ <b>0...10 V</b>	Output 6-Way-Valve responds to cooling power
<b>10</b>	Output 6-Way-Valve responds to heating power	100%...0% $\hat{=}$ <b>10...0 V</b>
<b>11</b>	100%...0% $\hat{=}$ <b>10...0 V</b>	Output 6-Way-Valve responds to cooling power

Tab. 011 Configuring the output 6-way valve

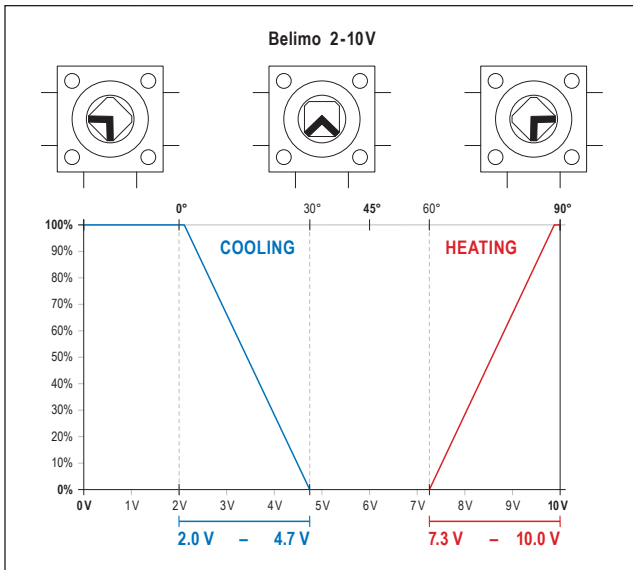

Fig. 919 6-way valve | Belimo (address 8020 = 2)

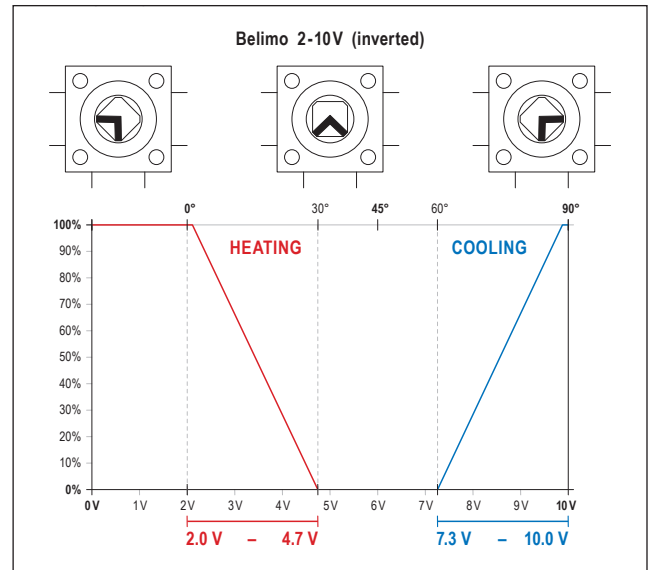

Fig. 920 6-way valve | Belimo inverted (address 8020 = 3)

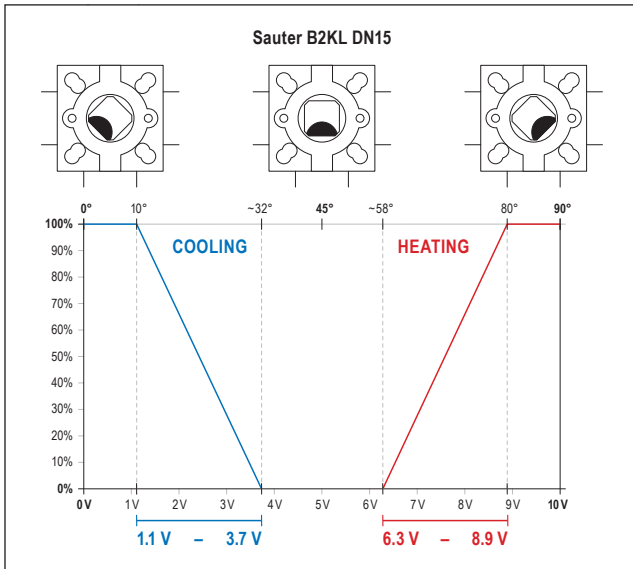

Fig. 921 6-way valve | Sauter DN15 (address 8020 = 4)

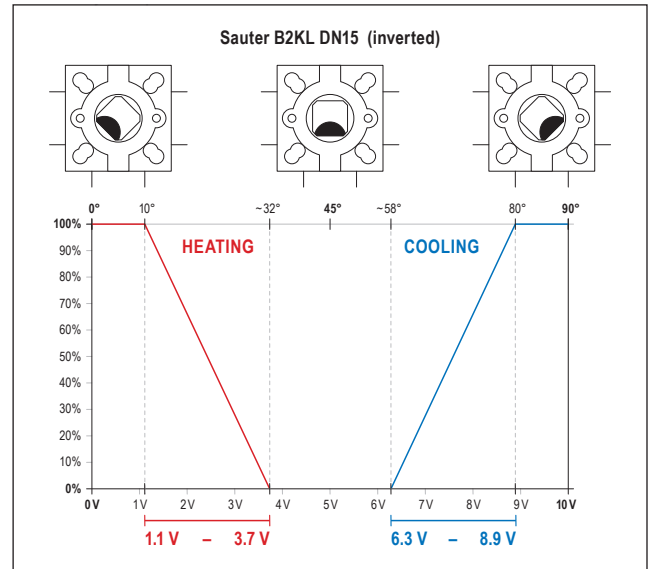

Fig. 922 6-way valve | Sauter DN15 inverted (address 8020 = 5)

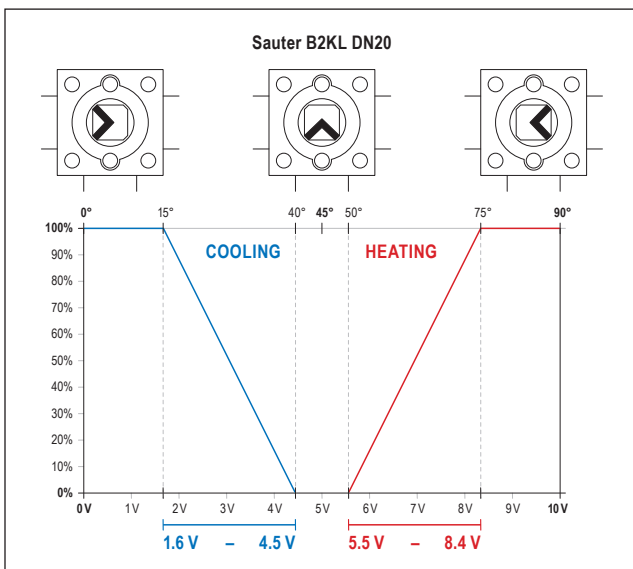

Fig. 923 6-way valve | Sauter DN20 (address 8020 = 5)

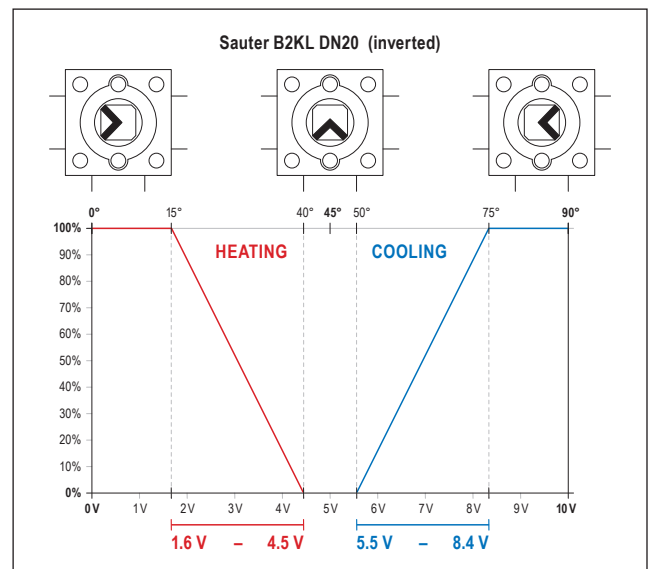

Fig. 924 6-way valve | Sauter DN20 inverted (address 8020 = 6)

Configuration register

**Time Program 1...48 (ZP)**  
 Holding adresse 7040...7515

For example TP1 and TP2:

TP1\_Activate\_7040  
 TP1\_EventDay\_7041  
 TP1\_EventHour\_7042  
 TP1\_EventMinute\_7043  
 TP1\_RegisterAddress\_7044  
 TP1\_Register\_NewValue\_7045

TP2\_Activate\_7050  
 TP2\_EventDay\_7051  
 TP2\_EventHour\_7052  
 TP2\_EventMinute\_7053  
 TP2\_RegisterAddress\_7054  
 TP2\_Register\_NewValue\_7055

**9.7 Time Program**

There are 48 freely programmable time channels available. Every time channel changes an entry in a Modbus register.

The register address, the new register value and the weekdays and time of the change are specified via the Modbus or via the PC configuration software (Fig. 925).

Furthermore, every time channel can be enabled or disabled individually. The last change has priority (Manual, Modbus, Time Program).

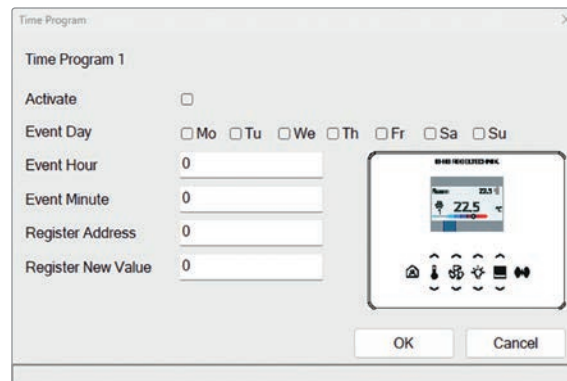

Fig. 925 Time Program | Configuration software (PC)

© Copyright by S+S Regeltechnik GmbH

Reprint in full or in parts requires permission from S+S Regeltechnik GmbH.

Subject to errors and technical changes. All statements and data herein represent our best knowledge at date of publication. They are only meant to inform about our products and their application potential, but do not imply any warranty as to certain product characteristics. Since the devices are used under a wide range of different conditions and loads beyond our control, their particular suitability must be verified by each customer and/or end user themselves. Existing property rights must be observed. We warrant the faultless quality of our products as stated in our General Terms and Conditions.

