

Surface contact temperature sensors /
surface temperature sensors,
with passive output

Small surface contact resistance thermometer in aluminium enclosure (cable sensor).
The surface sensor **THERMASGARD® OFTF** is used for temperature detection on flat or slightly convex surfaces, for instance for surface temperature measurement at windows, for monitoring formation of condensate, or as heating surface sensor, e.g. at windows or walls.

TECHNICAL DATA

Measuring range:	-30...+105 °C
Sensors / output:	see table, passive (Perfect Sensor Protection with IP68)
Connection type:	2-wire connection
Testing current:	< 0.6 mA (Pt1000) < 1.0 mA (Pt100) < 0.3 mA (Ni1000, Ni1000 TK5000) < 2.0 mW (NTC xx) 400 µA...5 mA (LM235Z)
Process connection:	attachment to the surface to be measured through fixing hole in the sensor head or by suitable adhesive
Protective sleeve:	aluminium
Dimensions:	8 x 8 x 50 mm
Connecting cable:	PVC; 1.5 m, LiYY, 2 x 0.25 mm ² , ends stripped with wire end sleeves (optional with silicone cable SiHF, up to +180 °C)
Insulating resistance:	≥ 100 MΩ, at +20 °C (500 V DC)
Permissible air humidity:	< 95 % RH, non-precipitating air
Protection class:	III (according to EN 60 730)
Protection type:	IP65 (according to EN 60 529) sleeve humidity-tight (standard) IP68 (according to EN 60 529) sleeve water-tight (optional)

1x two-wire connection
standard

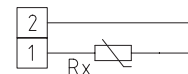

1x two-wire connection
LM235Z (KP 10)

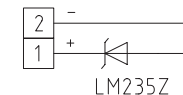

High-performance encapsulation against
vibration, mechanical stress and humidity



Dimensional drawing

OFTF

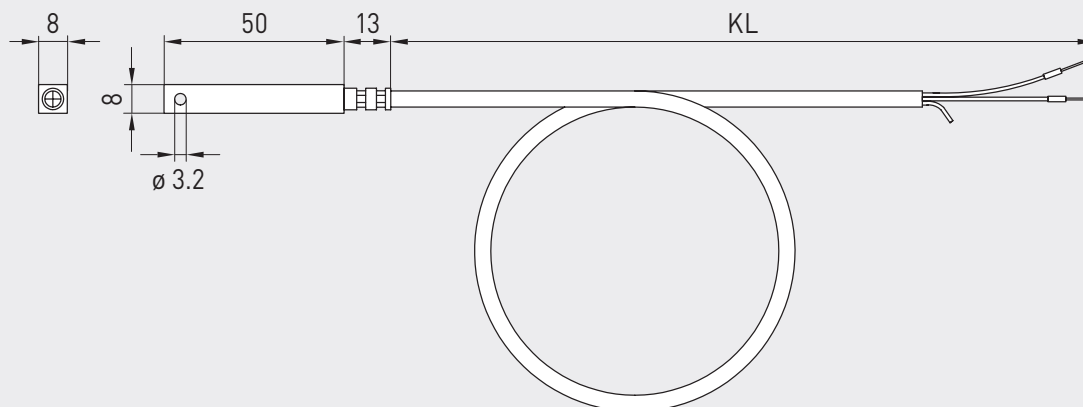



OUTF

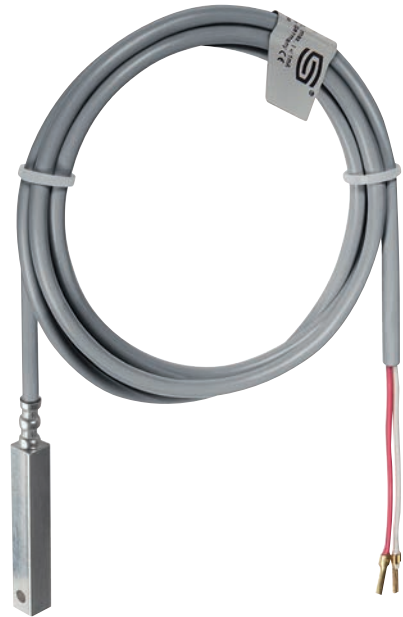

THERMASGARD® OUTF Surface contact temperature sensors / surface temperature sensors			
Type / WG03	Sensor / output	Item No.	Price
OUTF		IP65	
OUTF Pt100 PVC 1,5M	Pt100 (according to DIN EN 60 751, class B)	1101-6010-1211-110	40,81 €
OUTF Pt1000 PVC 1,5M	Pt1000 (according to DIN EN 60 751, class B)	1101-6010-5211-110	40,81 €
OUTF Ni1000 PVC 1,5M	Ni1000 (according to DIN EN 43 760, class B, TCR = 6180 ppm / K)	1101-6010-9211-110	43,17 €
OUTF NiTK PVC 1,5M	Ni1000 TK5000 (TCR = 5000 ppm / K), LG - Ni1000	1101-6011-0211-110	47,74 €
OUTF LM235Z PVC 1,5M	LM235Z (TCR = 10 mV / K; 2.73 V at 0 °C), KP10	1101-6012-1211-110	41,60 €
OUTF NTC1,8K PVC 1,5M	NTC 1.8K	1101-6011-2211-110	39,25 €
OUTF NTC10K PVC 1,5M	NTC 10K	1101-6011-5211-110	39,25 €
OUTF NTC20K PVC 1,5M	NTC 20K	1101-6011-6211-110	39,25 €
Extra charge:	Protection type IP68 (sensor sleeve watertight compound-filled) 2-wire connecting leads (PVC / silicone) per running metre 4-wire connecting leads (PVC / silicone) per running metre	on request on request	3,75 €
For special orders please specify:	Type, sensor type, cable length e.g. OUTF Pt100, 3m; OUTF Pt100 1 / 3 DIN, 4m; OUTF KTY 81-210, 6m		